

CPS 220/64/SV

Central Battery System and luminaires



INOTEC
Sicherheitstechnik GmbH

General information

With the publication of this catalogue, all previous versions lose their validity. During the period of validity of this catalogue, we reserve the right to make technical and formal changes to our products in order to improve them or to take account of changes in legal regulations. We are pleased to provide current data on request.

All LED luminaires are supplied incl. LED illuminant.

Industrial property rights exist for a large part of the products.

Current product information can be found on our homepage at www.inotec-licht.de

INOTEC Sicherheitstechnik GmbH

Innovative Emergency Lighting Technology



INOTEC Sicherheitstechnik GmbH is an innovative mid-sized company based in Ense-Höingen, Westphalia, with its own development, design, production and national and international sales.

A competent team with flexible and committed employees provides reliable support in all questions concerning products, planning, service and regulations.

Since its foundation in 1995, INOTEC Sicherheitstechnik GmbH has developed into a globally active company with over 310 employees. Further jobs have been created with the numerous partners within Europe and Middle East. The production, storage and administration facilities in Germany have grown to around 14,000m².

Today, INOTEC Sicherheitstechnik GmbH is one of the leading manufacturers in emergency and safety lighting. Modern, innovative and high-quality products "Made in Germany" set new standards worldwide, e.g. CLS 24 decentralised emergency lighting systems, central battery systems with JOKER technology and the dynamic escape route guidance D.E.R. system.

Contents

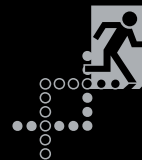

Function of the JOKER technology



CPS 220/64



INOView



Regulation and standards
Special colours
INOTEC LED technology



Luminaire

Contacts
Luminaire categories

Functionality

Function of the JOKER technology

- ▶ On an INOTEC CPS 220/64/SV three switching modes can be operated simultaneously and mixed. In addition to the system, JOKER electronic ballasts, the standard ballasts for INOTEC safety and emergency exit sign luminaires, are required, or an INOTEC J/SV module is placed in series with a third-party electronic ballast. By means of dip switches, the desired switching mode and monitoring address are set at both components.
- ▶ JOKER technology, patented by INOTEC, simplifies the design and installation of emergency lighting systems and saves considerable costs. The example on the left shows the possible extent of reductions in the installation.
- ▶ For conventional installation with three required standard operating modes maintained (M), non-maintained (NM) and switched maintained (SM), 6 final circuits are required to supply 9 safety and emergency exit sign luminaires in this part of the building.
- ▶ JOKER technology allows the number of circuits to be significantly reduced. In this example only 2 circuits are necessary, because all switching modes can be combined within one circuit.
- ▶ The different switching modes are only active in mains operation. In the event of a power failure, all connected lights are supplied by the battery and switched on, regardless of the selected switching mode.

Conventional Installation
6 circuits needed

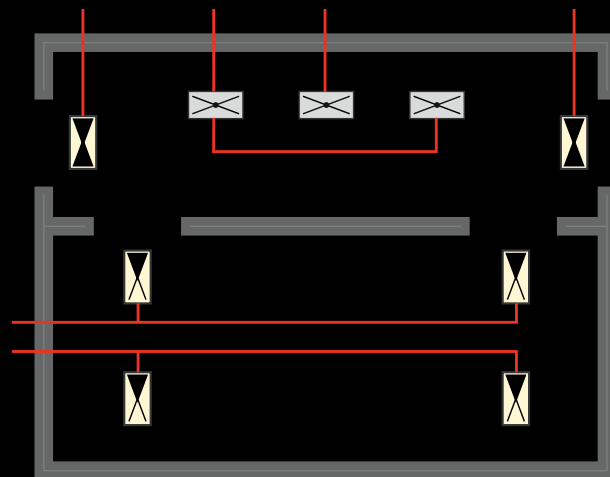

JOKER technology
only 2 circuits needed

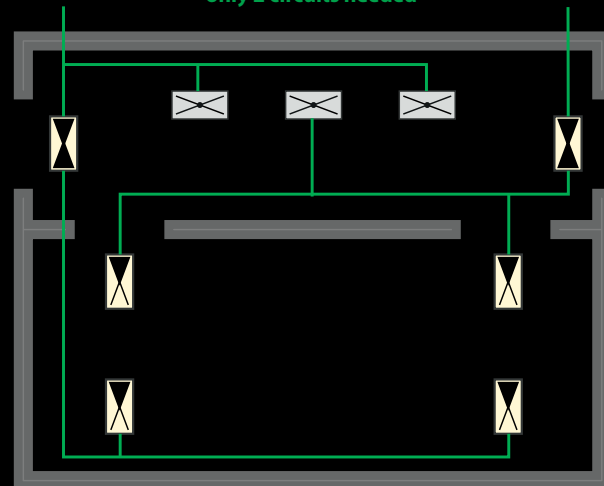

 Maintained light
  Switched maintained light
 Non-maintained light

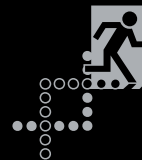

German patent number:
DE 19807844
European patent number:
EP 0939476



Advantages of JOKER technology

- ▶ Easy design of cable routing
- ▶ Reduced material costs
- ▶ Reduced installation time
- ▶ Better utilisation of the final circuits
- ▶ Subsequent or direct assignment of the switching mode to each luminaire

The CPS 220/64 provides three switching modes for emergency exit sign and safety luminaires in the same circuit without additional data lines.

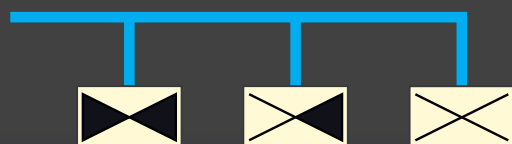
3 (L/N/PE)



-  Maintained light
-  Switched maintained light
-  Non-maintained light

Functionality

Are escape routes always safe escape routes?

Using the CP D.E.R. 2x2.5A change-over device, the CPS 220/64 system provides additional dynamic control of low-level lighting and dynamic emergency exit sign luminaires via a BUS cable. If fire or smoke block the next escape route, these luminaires can indicate an alternative and safe evacuation route.

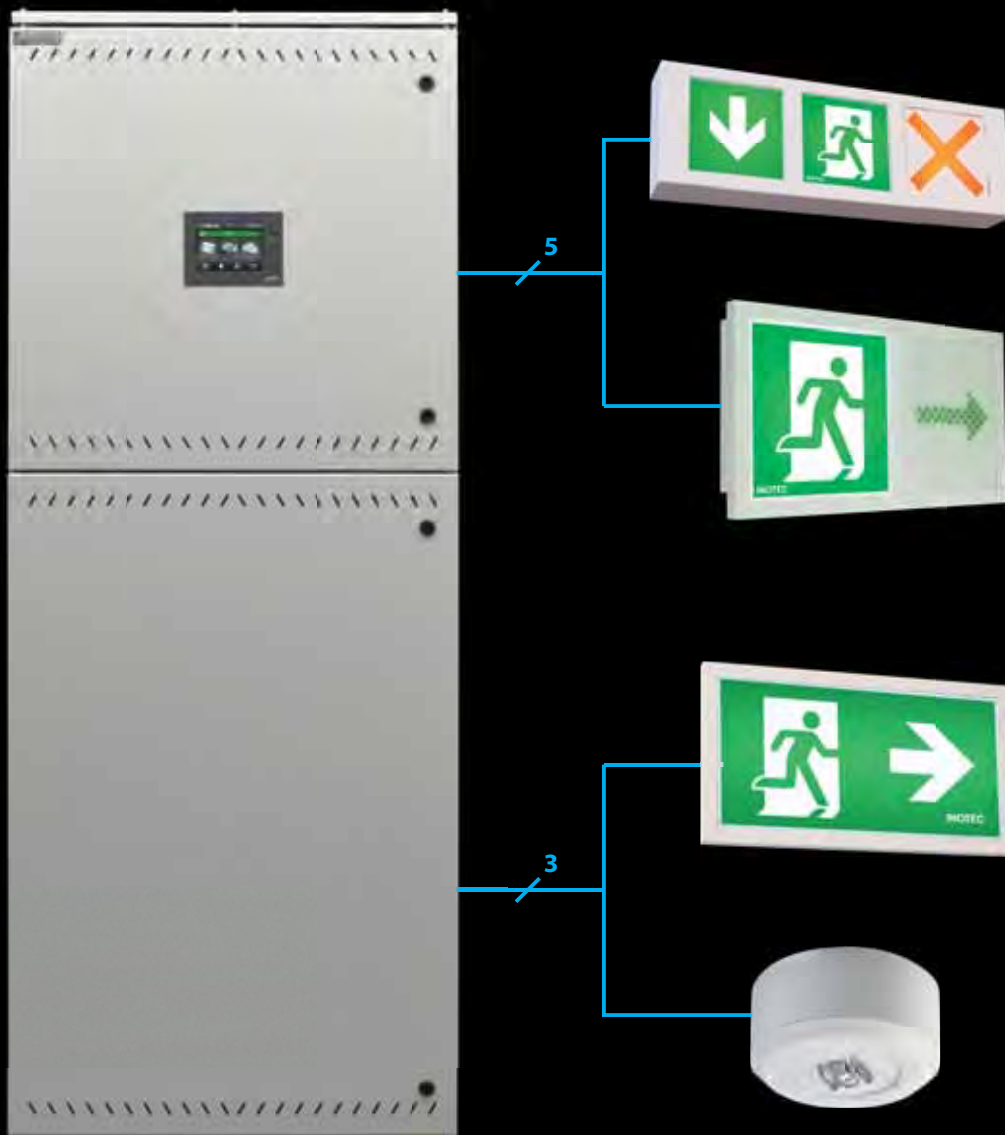

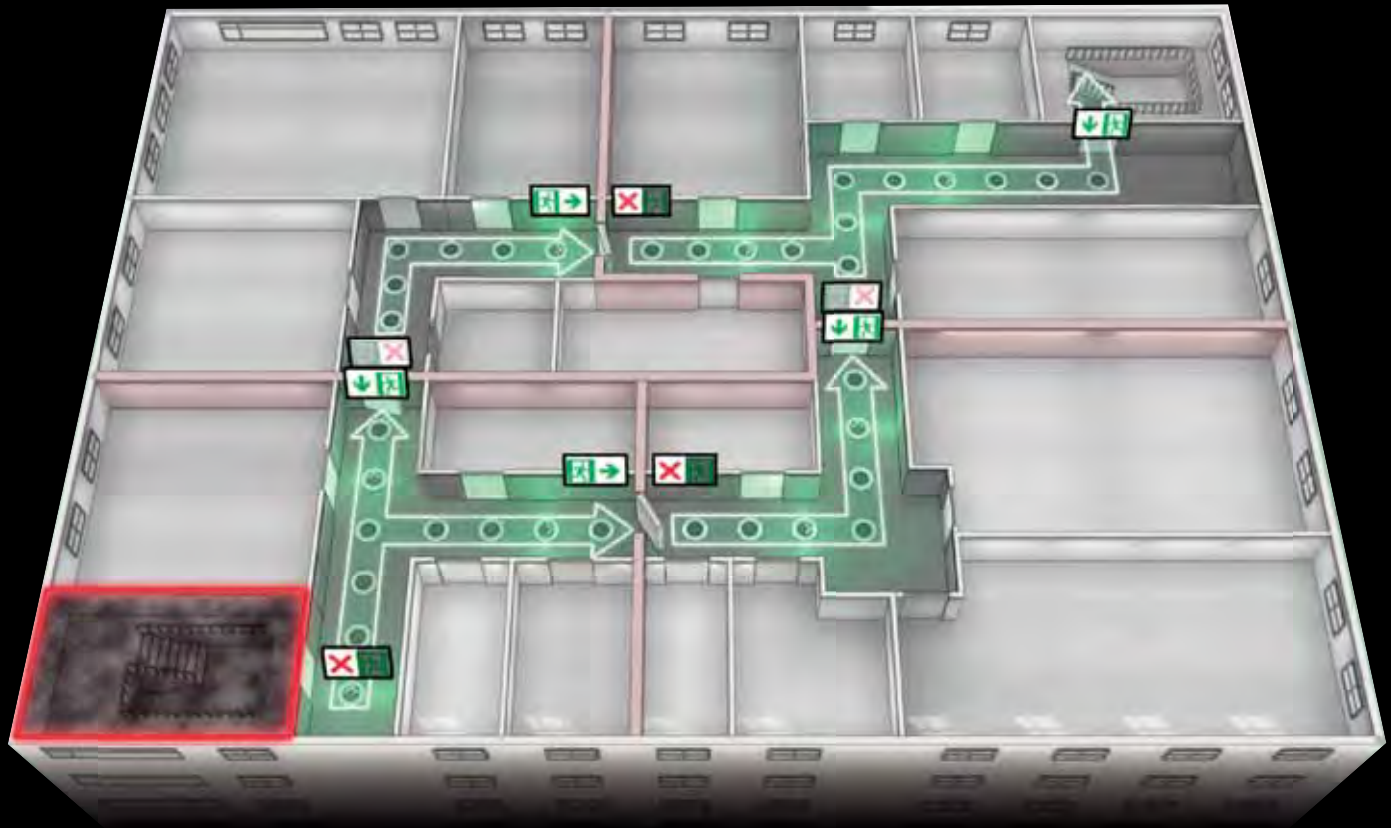

Dynamic escape route solutions are becoming more and more common for changes in the use of buildings or to compensate structural fire protection measures.

If an escape route cannot be used or can only be used in a limited way, a static marking may no longer fulfil its purpose. This may be the case, if escape doors are locked due to the special use of building parts (e.g. at events in schools).

Without an additional system, you can operate dynamic exit sign luminaires on a CPS 220/64. Structural requirements, the type and use of areas or buildings and regulatory and legal requirements can be easier achieved with CPS 220/64.

A maximum of 8 switch inputs can be assigned to each dynamic emergency exit sign luminaire on a CPS 220/64 to control the luminaire depending on the situation.



Functionality

System Layout and features

The modular design of the CPS 220/64 central battery system with different power ratings and cabinet sizes makes it possible to adapt to all project requirements. In case of an emergency, the safety and emergency exit sign luminaires are supplied by the sealed OGi block battery (216V DC).

The integrated controller checks the system continuously and monitors each connected luminaire (max. 20 addresses per circuit). An individual luminaire monitoring system in the central battery system detects and reports the failure of an individual luminaire including the stored location text. For each circuit, the type of monitoring (not monitored, circuit monitored, single luminaire monitoring) and operating mode are individually programmable.

- Modular system design, various cabinet variants, battery racks or cabinets available
- Monitoring and supply of 20 addresses for up to 128 circuits with individual luminaire monitoring
- Low service costs by central monitoring of the entire safety lighting system and all connected luminaires
- Automatic or manually triggered function test which includes logbook for status and error information
- Insulation test device
- Disconnect terminals for simple insulation measurement of final circuits
- Patented JOKER technology: mixed operation of maintained, non-maintained and switched maintained light
- Location text displayed at controller down to luminaire level



External BUS components

The functionality of the new CPS 220/64 can be extended by connecting external, bus-capable components such as light switch application modules (LSA) or three-phase monitoring modules (DPÜ). Especially the bus-capable three-phase monitoring module enables a detailed reporting of the faulty sub-distribution at the CPS 220/64 controller with forwarding the information to a connected monitoring system.

A phase failure can be used for selective switching of individual luminaires or the triggering of dynamic escape route scenes.

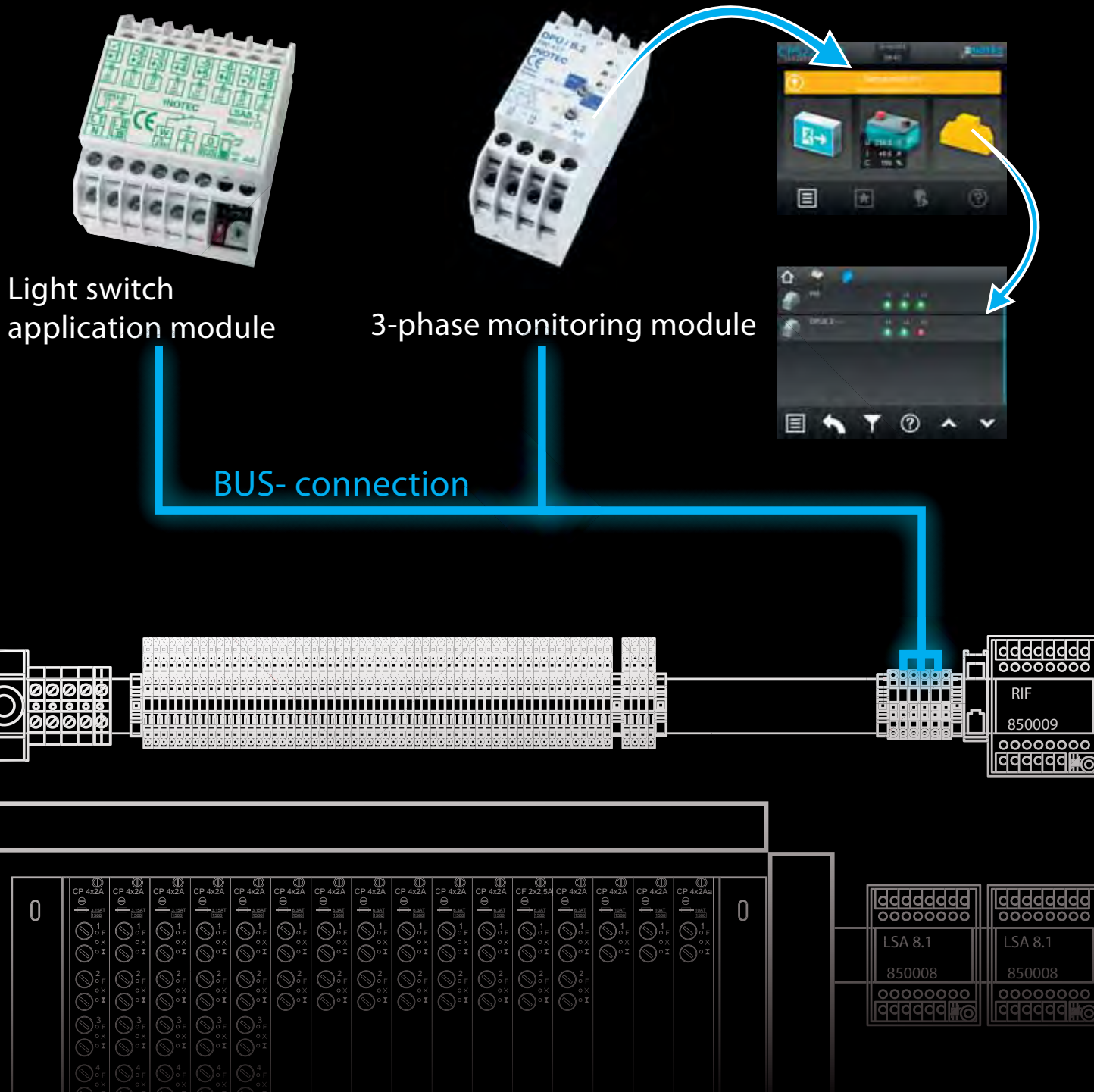

Functionality

230V-change-over-devices

Change-over-device for connection of 230V safety- and emergency exit sign luminaires

- ▶ Automatic monitoring function of the connected 230V luminaires
- ▶ Monitoring without additional data line
- ▶ Single luminaire or circuit monitoring with JOKER technology for each circuit programmable
- ▶ Assignment for up to 3 switching inputs



230V - D.E.R. change-over-device



Using the CP D.E.R. 2x2.5A circuit module for the CPS 220/64, it is also possible to operate, monitor and control 230V luminaires of our Dynamic Escape Route Guidance System D.E.R. on central battery system. Dynamic direction indicators with running light function in combination with the segment controller (SEV) and a regulated power supply (PSU) can also be operated with this module.

- ▶ Automatic function monitoring of the connected 230V-D.E.R. luminaires
- ▶ Assignment of up to 8 switching inputs per luminaire

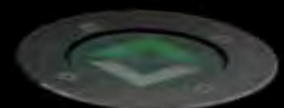

The dynamic escape route luminaire with running light function, which are mounted at a low level, and the dynamic emergency exit sign luminaires are controlled to indicate safe escape routes in the event of a fire.



24V technology

The 24V technology is now also available as a slot card for CPS 220/64. This makes it even easier for you to use the advantages of 24V technology.

- ▶ Automatic function monitoring of the connected luminaires
- ▶ Each luminaire individually programmable at the TFT controller
- ▶ Assignment of up to 2 switching inputs per luminaire
- ▶ Luminaires can be dimmed individually
- ▶ 2 output circuits with protection class III (SELV) for up to 20 luminaire addresses per circuit
- ▶ Luminaire addressing without address switch



The 24V slot card combined with new D.E.R. luminaires can be used to dynamically re-route escape routes in the event of a fire. A separate escape route guidance system with an independent D.E.R. controller is therefore no longer necessary.



Also available as BUS substation with the following additional functions:

- ▶ Integrated circuit separating module
- ▶ Local 24V current loop
- ▶ Optimal for one fire compartment



System luminaires with 24V technology can be found in the CLS FUSION catalogue.





Functionality

Safe enclosure for safe operation

According to (M)LAR, safety lighting systems are safety-related systems. If these systems supply more than one fire compartment, the electrical wiring must be designed in accordance with (M)LAR 5.3.2. in the version of 20.05.2015 with a functional preservation of at least 30 minutes. This is not always possible with a separate room that is not used for other purposes. An alternative in accordance with (M)LAR 5.2.2. is to place the safety-related systems in an enclosure with appropriate functional preservation. For the enclosures, the function of the electrotechnical components of the distributor must be demonstrated in a structural proof of usability for the duration of the functional preservation in the event of fire.

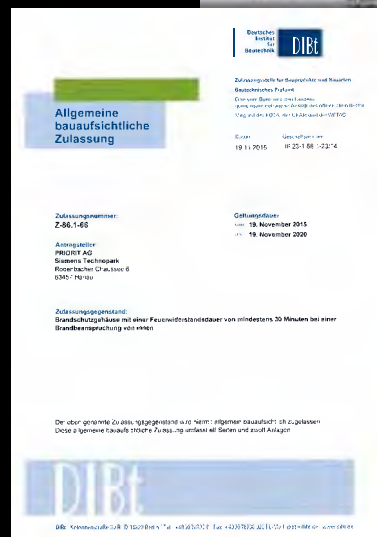
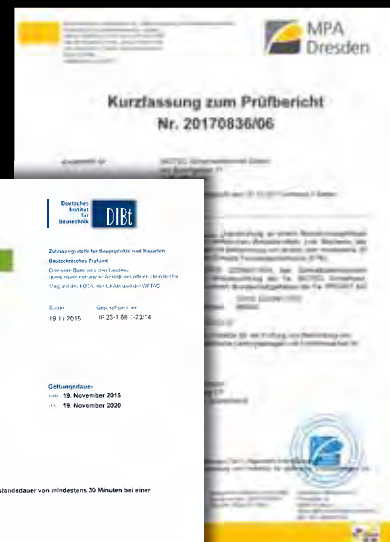

For our central battery system CPS 220/64 INOTEC Sicherheitstechnik offers corresponding system housings with functional preservation optionally. In a fire chamber test at a national material testing office, the fire protection housings BRS including the electrical components of the CPS 220/64 were tested successfully. The enclosures used have been approved by the German Institute for Building Technology (DIBt) for fire exposure of at least 30 minutes from inside and outside.

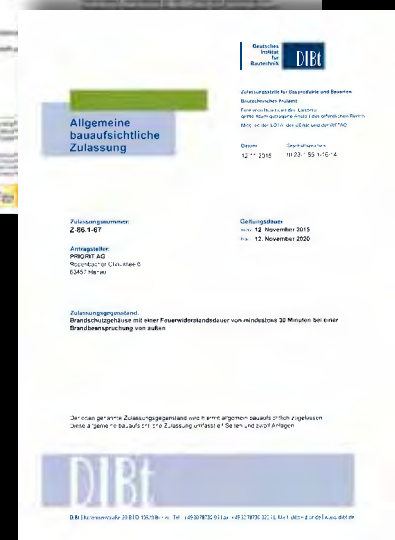
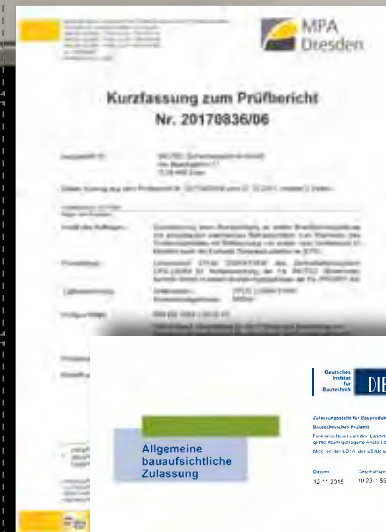
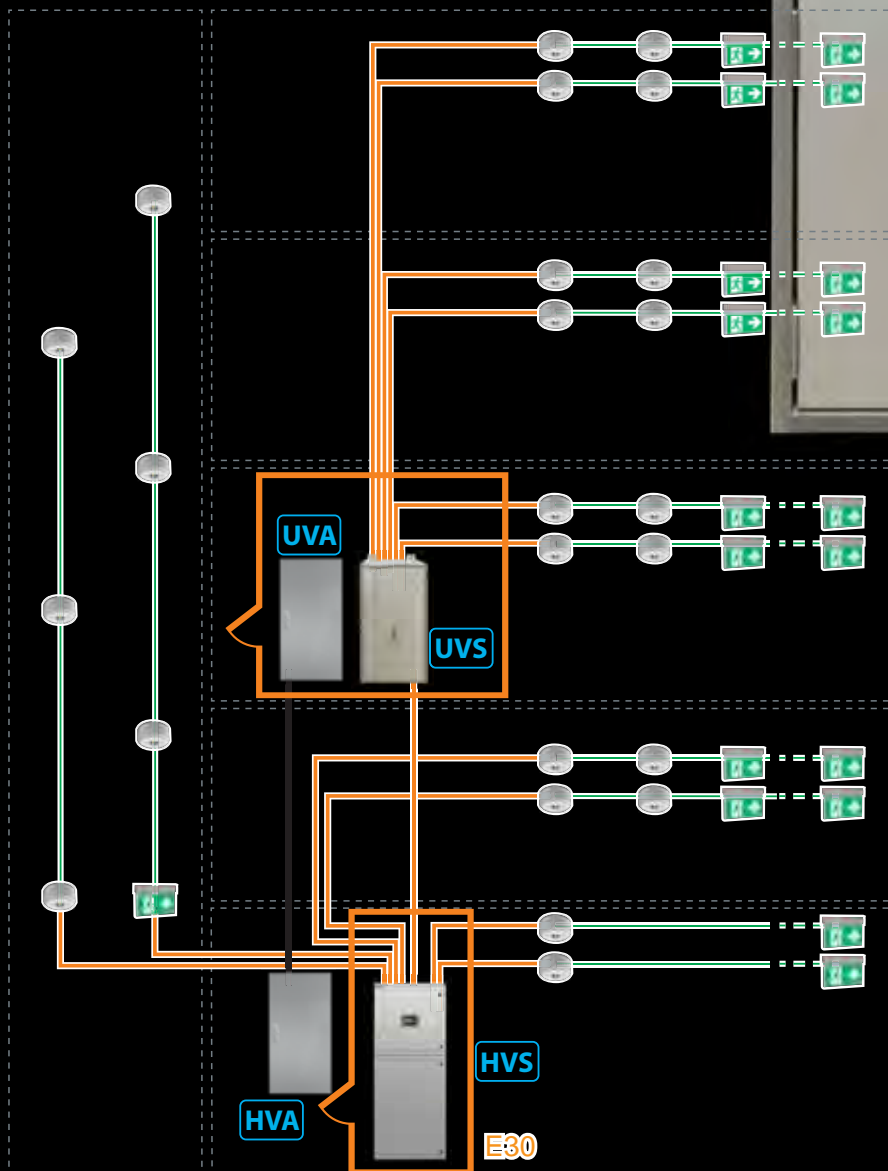
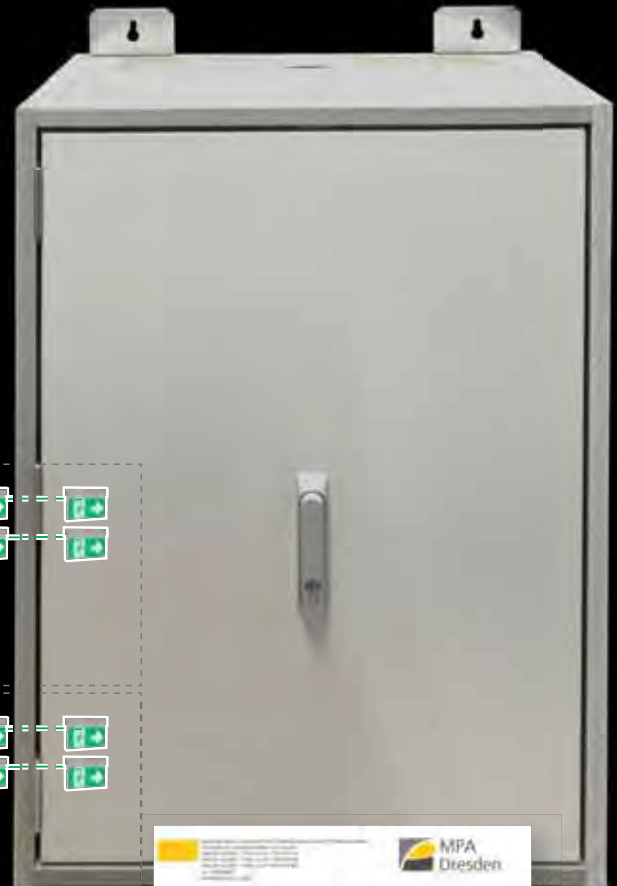

Safety

Is your emergency lighting system always ready for use in an emergency?

Emergency lighting systems must be ready for immediate use in the event of an emergency, as they must enable safe evacuation of the building for the rated duration time in the event of a power failure. This requires not only constant monitoring of the safety and emergency exit sign luminaires and the switching technology, but also monitoring of the batteries used. Customary market systems are often just monitoring the symmetry of the battery set. The battery pack is divided into 9 blocks each. Individual block monitoring is not performed.

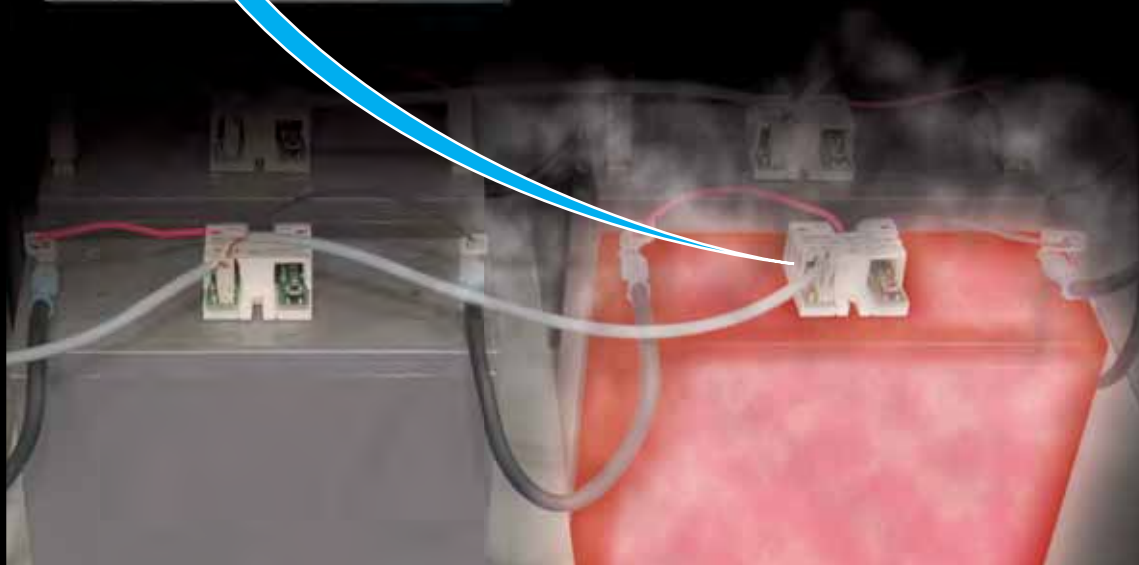

Failure types

- ▶ **Drying-Out**
The electrolyte bound in the fleece or gel also dries out during normal operation. This is neither visible from the outside nor can it be prevented by maintenance. A battery block defect will result.
- ▶ **Thermal runaway**
The heat generated e.g. by an internal short-circuit accelerates exothermic (heat-generating) reactions within the battery so that even more heat is generated. This can lead to the emission of smoke or flames or even an explosion of the battery block.
- ▶ **Plate short circuit**
Out flushed material, which is gathered at the bottom of the battery, may cause a short circuit between the cells.
- ▶ **Sudden Death**
By corrosion at the connection between plates and the pole bolt the material thickness can decrease and finally break off. This leads to the so-called sudden death.

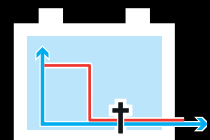
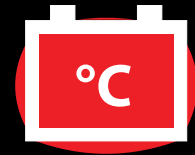
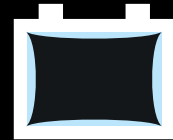

Why to use a battery control system?

The INOTEC BCS-system monitors and logs voltage and temperature of each individual battery block.

If pre-defined limit values of an individual battery block are exceeded or not reached, fault messages are first sent and finally the charger is switched off.

Since all 18 battery blocks in a central battery system are connected in series, a single defective block can also destroy the remaining blocks over time. Therefore the early detection of a defective battery block is absolutely necessary. Otherwise, operational reliability is no longer guaranteed until the battery block is replaced. In the worst case, this can only be deter-

mined during the next annual endurance test.

Even during a weekly function test, a single defective battery block is not detected. For the duration of the test, the energy of the remaining blocks is sufficient, but in the event of a longer power failure, this would lead to the failure of the entire battery system within a very short time.

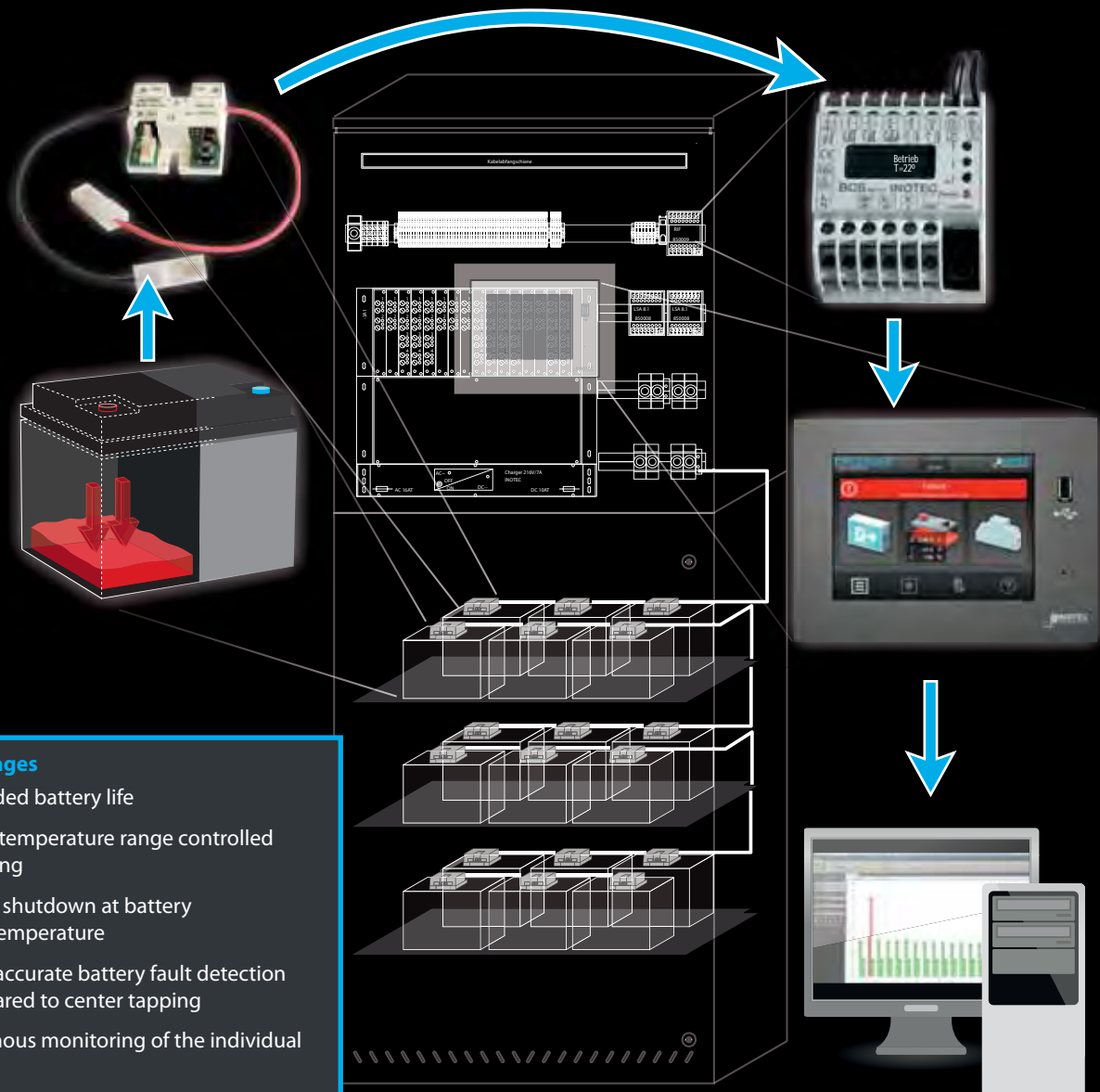

Advantages

- ▶ Extended battery life
- ▶ Perm. temperature range controlled charging
- ▶ Safety shutdown at battery over-temperature
- ▶ More accurate battery fault detection compared to center tapping
- ▶ Continuous monitoring of the individual blocks
- ▶ Logging of battery block voltage and temperature
- ▶ Safety shutdown of the charger and cancellation of a duration test in the event of a fault
- ▶ Battery data logging

Functional example using a CPS FUSION system



Do you always document the required battery tests?

According to EN 50171:2001, the total voltage, charging current and ambient temperature of the battery set must be constantly monitored, but these values are not sufficient to determine the operating status of the battery.

Accordingly, EN 62034:2013 requires an annual duration test to check the battery capacity over the entire operating period. The block voltage of the individual battery blocks is also to be measured. This annual inspection only determines the condition of each individual battery block 365 days apart. It is impossible to give a statement about the condition of each battery block in the meantime.

The draft of EN 50171:2013 specifies that the voltage of each battery block has to be measured and recorded. If a system such as the INOTEC BCS system is used, this monitoring system must meet the following requirements:

- ▶ Periodic monitoring of the battery block voltages (6.11.3. a)
- ▶ Failure messages at a deviation of the battery block voltage (6.11.3. b)
- ▶ Only manual resetting of failure messages (6.11.3. d)
- ▶ Logging the battery block voltages during a duration tests in 5 minute intervals (6.11.3. f)
- ▶ Monitoring the battery temperature (6.11.)

The INOTEC BCS system already meets future requirements today and records the battery condition in the logbook of the system.

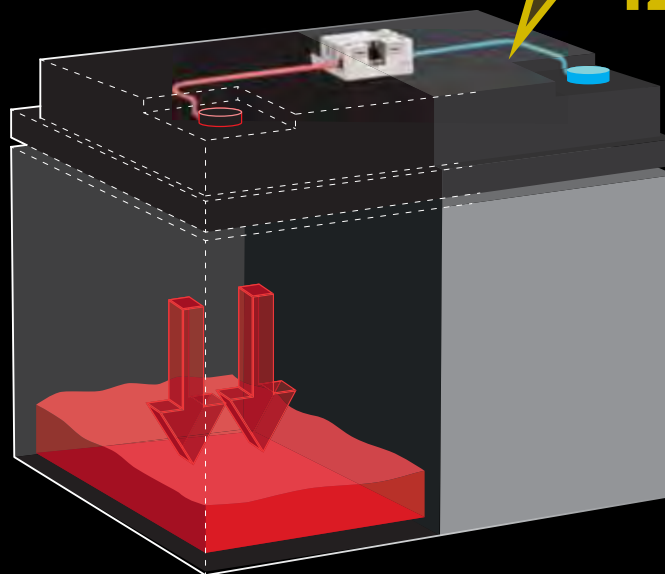
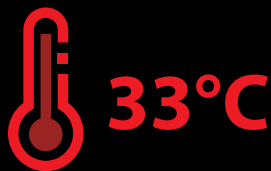

BCS View - A New View

Using the convenient analysis software BCS View, the recorded data of the BCS system can be evaluated in detail. Diagrams clearly visualise the condition of the individual battery blocks during normal operation as well as during a duration test. Defective battery blocks can be easily located with the help of this intuitive software.

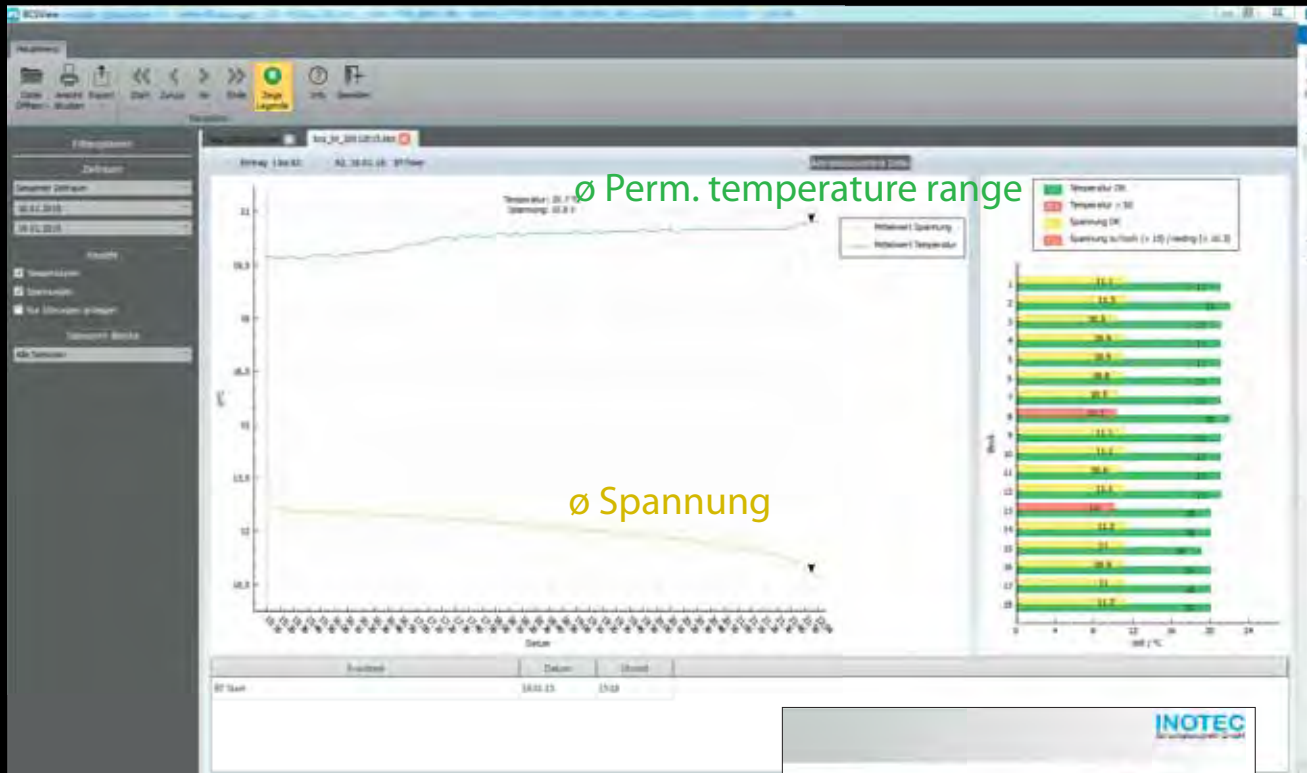

The log of a duration test clearly shows the decreasing average voltage of the battery blocks (green) over the duration of the test. Exceedances of the limit values are indicated in red. This immediately notifies the user of the need for verification when viewing the recorded data.

The data is read out from the TFT controller of the emergency system via a network connection or USB stick and visualised in the BCSView software. The BCS system logs the daily measurement data and the measurement data during a duration test in two separate test files.

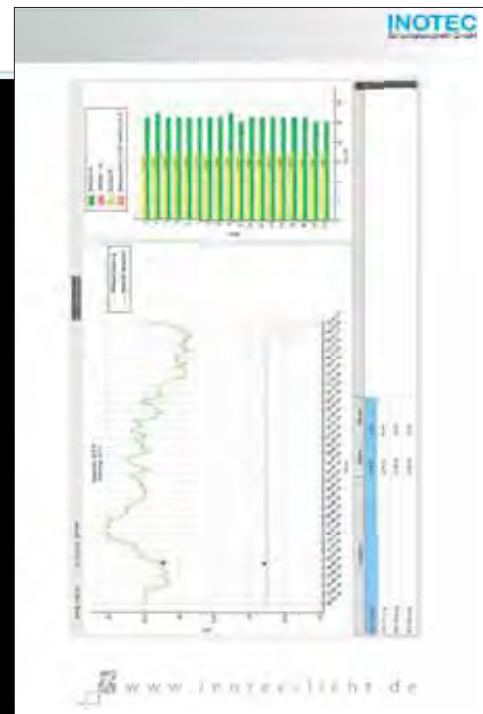

Ease of use

User-friendly operation

The modern graphical user interface of the TFT touch display of our central battery system CPS 220/64 allows a very comfortable and intuitive operation.

The habits of the users changed a lot due to smartphones and tablets. INOTEC takes up the concepts and simplifies the usage of your emergency lighting systems.

The 5" TFT-WVGA-Touch display of the CPS 220/64 shows all status information down to luminaire level. The graphic display has been optimised for finger operation.

As a result of the consistent user interface for our centralised and decentralised emergency lighting systems the user does not need to adapt to a different usage.



Control down to luminaire level

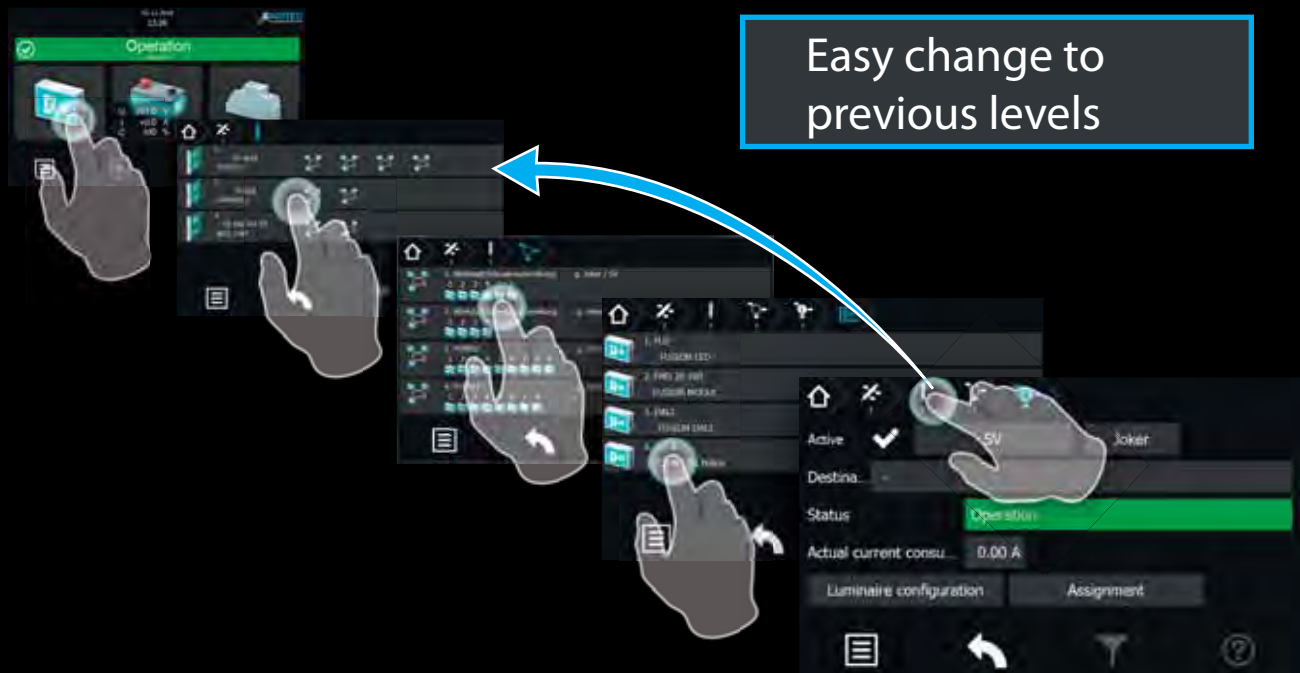

Display of logbook at controller

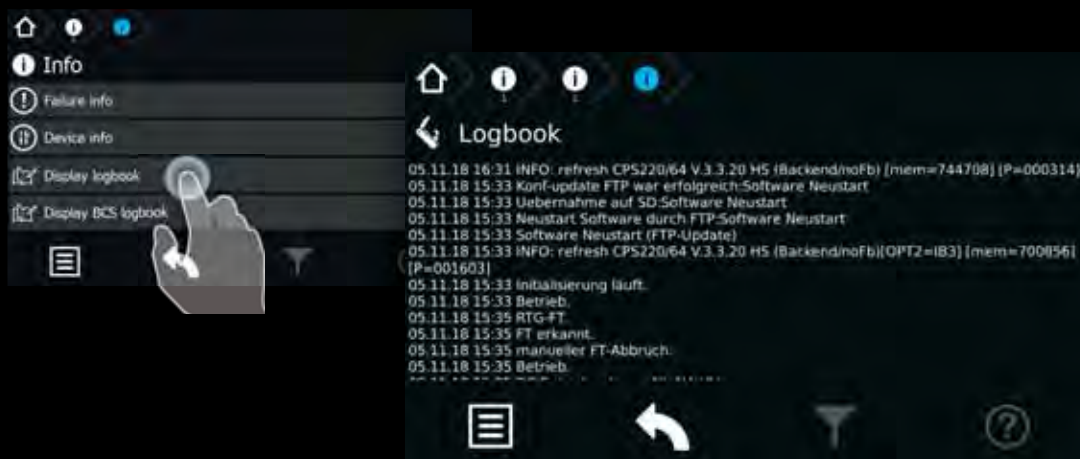

 **Versatility**



The CPS 220/64 central battery system optimally meets your project requirements with its different rating classes and cabinet designs. Modularly equipped with 16 internal and 16 external slots with 1, 2 or 4 circuits, the system can be adapted to all customer requirements.

Increasing requirements for dynamic escape route guidance are easily realised with the CPS 220/64. The operation of dynamic luminaires in the same system with static luminaires simplifies planning and installation. Especially when controlling only one or two dynamic luminaires, there is no need to install a second system.



The 5" TFT-WVGA controller with graphic touch surface is built into the door of the electronic cabinet of the CPS 220/64 central battery system. This makes it possible to operate the emergency lighting system conveniently without opening the cabinet door. The integrated password protection prevents from unauthorised operation.

The new cable entry across the entire width of the cabinet allows the cables to be fed into the cabinet individually or in bundles. The sliding rubber seal simplifies the insertion of large cable cross-sections and seals the cable entry after installation. Inside the cabinet, the optimised design eliminates the need to jump to the terminals, resulting in a larger connection space.



Connectivity

Thanks to the multiple interfaces on the control unit of the CPS 220/64, this system offers a wide range of monitoring and programming options.

Using the standardised USB interface, information can be stored on a USB pen drive or the configuration of the system can be updated. The controller software can also be easily updated using USB.

The integrated network interface enables information to be transferred to monitoring systems. By default, the information can be accessed with a web browser via PC or mobile via INOWeb. All status information down to the individual luminaire fault are visualised.

Of course, the central battery system can be monitored with the INOView software. The status of luminaires, BCS and connected components is clearly displayed in INOView with location information. Events are logged centrally in the logbook of all monitored systems. For faster localisation of the faulty luminaire, these are displayed in a floor plan with the current luminaire status.

Status messages to building management software can be sent via ModBUS/TCP. In this way, the information can be displayed down to the luminaire level in an existing building management system. Other standard building management system protocols such as OPC or BACnet can also be implemented by gateways.



INOWeb

TFT-touch controller with integrated INOWeb function for central monitoring of the emergency lighting device via intra-/ internet. The connection works via an already existing network.

Monitoring of the emergency systems using a web browser to access the INOWeb functionality of the control unit. Every system, circuit and luminaire status can be monitored via the (optionally) password-protected website.

With an existing internet connection the INOWeb can be accessed from any place world-wide. Please contact your regional sales team for a demonstration.

Functions:

- + Starting a function test/ battery duration test
- + Blocking /releasing
- + Failure printout
- + Linking files / websites by circuit

The INOWeb-Control software makes it possible to monitor even complex installations with different system types from a central location. Therefore the TFT-touch controller needs to be integrated in an existing network.

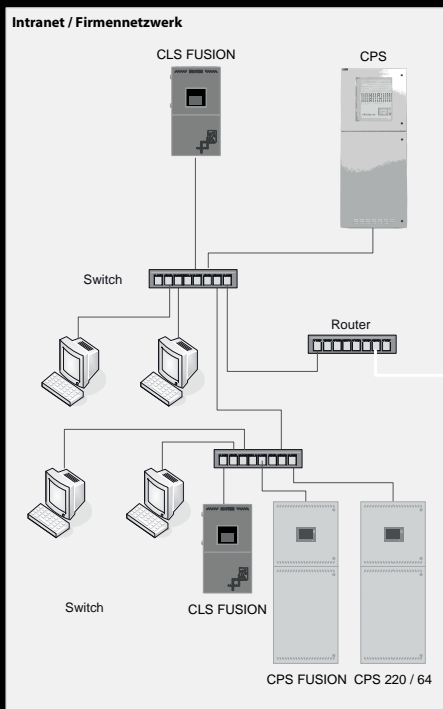

IP	Name	Main unit	Location	Status	Website
10.1.20.100	Testgerät RIFB		Werkstatt	Online	10.1.20.100
10.1.20.2	CLS 24V		Werkstatt linke Wand	Offline	10.1.20.2
10.1.20.5	CLS 24V		Labor PM	Online	10.1.20.5

INOWeb-Control functionalities :

- + Monitoring up to 25 INOTEC emergency lighting systems , can be extended
- + Automatic function / duration test programmable
- + Logbook function for all connected systems
- + Automatic email transmission, at user-defined intervals, in case of test or failure
- + Overall status of all systems is indicated by a symbol in the taskbar

 **Connectivity**

INOView - flexible monitoring

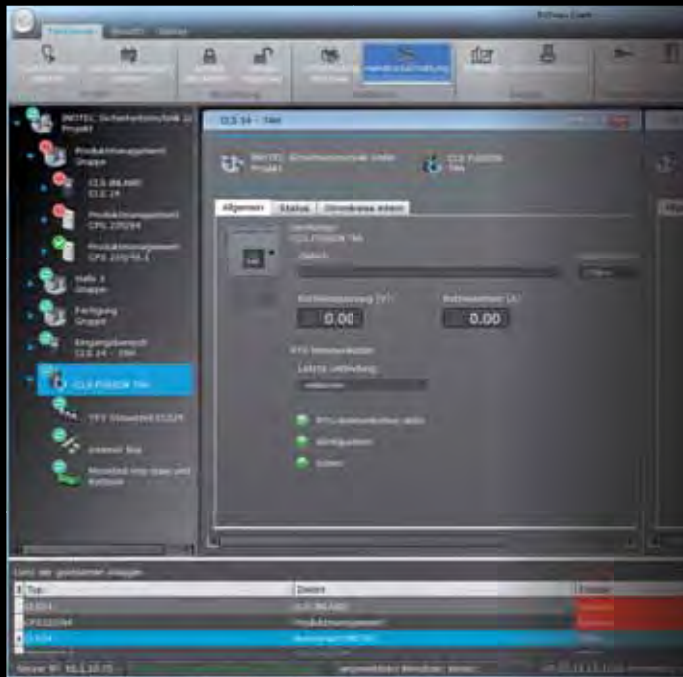

INOView is the main monitoring solution for all INOTEC emergency lighting systems. This software is used wherever a flexible application is required that can grow with the project. The devices are monitored via a 3-core RTG bus and/or a network connection.

Everything in focus for personal safety in buildings

When developing the INOView visualisation software, we focused on the user. Simple, intuitive user interface and transparency by clearly structured system images and clear texts are important. With just one view, the user can see the overall status of the safety lighting system and, if necessary, quickly initiate measures to guarantee personal safety in the building. The INOView software ensures transparency and provides the user with comprehensive and detailed information on system operation.

State of the art client-/server – architecture

A modern client/server architecture ensures future and investment security. The clients allow several users in the network to access the information of the INOView software simultaneously. An integrated user administration protects the software from unauthorised access.

Powerful and easy to use



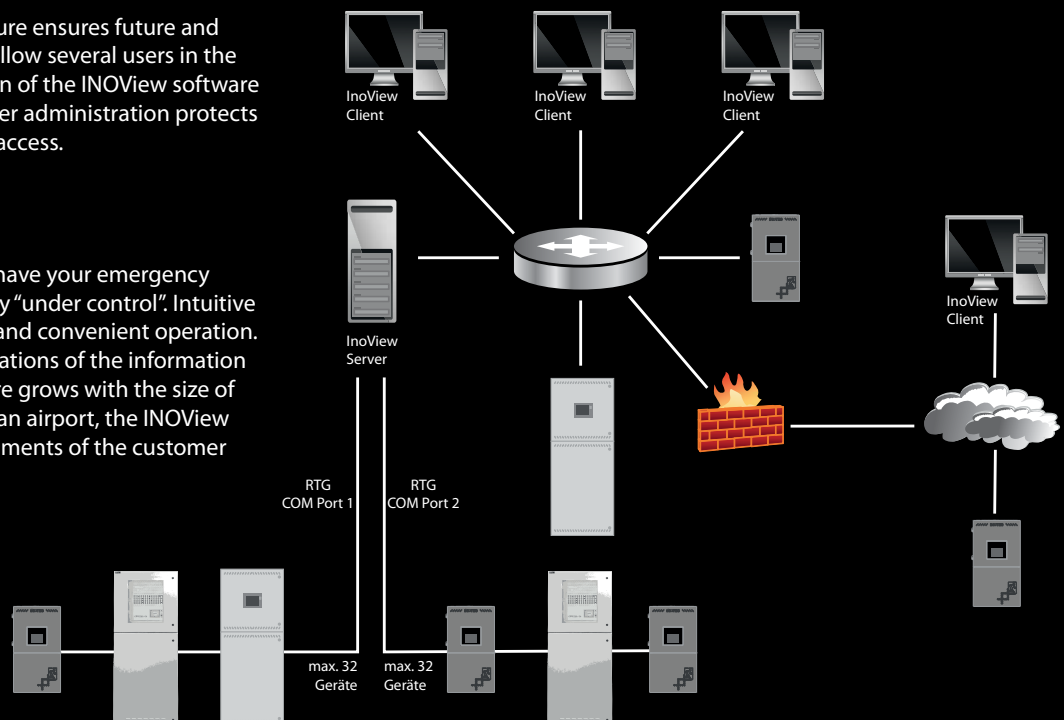







With the INOView software, you have your emergency lighting systems clearly and safely “under control”. Intuitive operating menus enable simple and convenient operation. Individually configurable visualisations of the information ensure transparency. The software grows with the size of the project. Whether a school or an airport, the INOView software is aligned to the requirements of the customer with modern standards.



Planning example of a CPS system

1. Circuit design

- Define circuits and used luminaires
- Sum the nominal currents

SK 1.1	SNP 1530 	SNP 1520 	SN 9400 ALB 	$\Sigma I_{SK1.1} = 0,264A$ $S_{SK1.1} = 76,7VA$
	18mA/5,2VA 7 pieces	14mA/4,1VA 3 pieces	12mA/3,5VA 8 pieces	
	<hr/>			
SK1.2	SNP 1530 	SN 9400 ALB 		$\Sigma I_{SK1.2} = 0,21A$ $S_{SK1.2} = 61VA$
	18mA/5,2VA 5 pieces	12mA/3,5VA 10 pieces		
	<hr/>			
SK1.3	SNP 2130 	SN 804 	SN 6204 	$\Sigma I_{SK1.3} = 0,445A$ $S_{SK1.3} = 118,5VA$
	32mA/8,3VA 4 pieces	32mA/8,3VA 6 pieces	25mA/7,1VA 5 pieces	
	<hr/>			
SK1.4	SN 6204 	SN 2130 		$\Sigma I_{SK1.4} = 0,328A$ $S_{SK1.4} = 90VA$
	25mA/7,1VA 8 pieces	32mA/8,3VA 4 pieces		
	<hr/>			
SK2.1				$\Sigma I_{SK2.1} = 0,416A$
SK2.2				$S_{SK2.1} = 112,9VA$
•				$\Sigma I_{SK2.2} = 0,506A$
•				$S_{SK2.2} = 137,4VA$
•				•
SK11.4				$\Sigma I_{SK11.4} = 0,42A$
				$S_{SK11.4} = 111,4VA$
				Total current = 21.5A
				Total power = 6.125KVA

Design example for emergency lighting with a CPS system

2. Calculation of battery / ageing reserve

If lead-acid batteries are operated as intended, a capacity loss of up to 2.5% per year (25% in 10 years) is to be expected as a rule. According to EN 50171, this capacity loss must be taken into account when determining the battery in order to achieve the full nominal operating life at the end of the life expectancy of 10 years.

The end of a battery's lifetime is reached when, at the end of the nominal operating time, the nominal voltage of the battery drops below 90% at nominal load.

Battery discharge current 21.5A + 25% ageing reserve = 26.9A

For the safety lighting of a conference centre with a required nominal operating time of 3 hours, a type 20-90 battery is required according to table 1.

3. Calculation of charge current / quantity of chargers

According to EN 50171, discharged batteries must be recharged to 80% of their discharged capacity within 12 hours. The ageing reserve must not be taken into account when calculating the necessary charging current.

With a battery discharge current of 21.5A over a nominal operating time of 3 hours, the following results apply for the selected battery type 20-90 according to table 2: 1 charger 7A

4. Ventilation of battery room

According to EN 50272-2, for battery rooms there is a necessary air flow needed using the following formula

$$Q = v \cdot q \cdot s \cdot n \cdot I_{gas} \cdot CN \cdot 10^{-3} \text{ [m}^3\text{/h]}$$

and necessary inlet and outlet vents according to $A = 28 \cdot Q$.

According to table 2, for the selected battery there is a necessary air flow rate of $Q = 0.49 \text{ m}^3\text{/h}$ and inlet and outlet vents in the battery room of 13.8 cm^2 .

5. Protection rating of the mains input

The entire connected load of the CPS 220/64 system is to be used to determine the fuse protection in the main distribution board of the general power supply.

It results from the mains connection power of all connected luminaires and the number and type of the chargers.

Total power rating of luminaires = 6.13 kVA

Power rating of charger 216V / 7A = 1.82 kVA

Total power rating system: $S = 7.95 \text{ kVA}$

Table 1

Battery type, cabinets, weights, dimensions and discharge currents

Battery type	Discharge current [A]				Blocks	Weight [kg]		Cabinets	Racks
	1h	2h	3h	8h		Block	Total		
C ₁₀ -1.8V/Z									
20-12	7.2	4.1	3.0	1.4	18	4.1	73.80	600 x 600 x 300 mm	
20-18	10.7	6.2	4.4	1.8	18	6.3	113.40	1000 x 600 x 300 mm	
20-28	16.2	9.5	6.8	2.9	18	9.5	171.00	1000 x 600 x 300 mm	
20-33	19.9	11.1	7.5	3.4	18	10.9	196.20	1200 x 800 x 400 mm	
20-40	24.1	13.7	9.8	4.3	18	13.6	244.80	1200 x 800 x 400 mm	
20-55	33.2	18.5	12.9	5.5	18	22.5	405.00	1200 x 800 x 400 mm	
20-70	45.3	25.8	18.4	8.0	18	27.7	498.60	1200 x 800 x 400 mm	
20-70-1	53.2	28.3	19.1	8.0	18	25.4	457.20	1200 x 800 x 400 mm	
20-80	48.3	27.5	19.6	9.4	18	24.0	432.00	2 x 1200 x 800 x 400 mm	Type 1
20-90	66.9	37.8	27.4	11.4	18	32.8	590.40	2 x 1200 x 800 x 400 mm	Type 1
20-100	60.4	34.4	23.9	10.3	18	30.5	549.00	2 x 1200 x 800 x 400 mm	Type 1
20-135	91.0	50.2	34.0	13.8	18	40.6	730.80	2 x 1200 x 800 x 400 mm	Type 1
20-120	72.5	41.3	29.4	14.1	18	35.0	630.00	3 x 1200 x 800 x 400 mm	Type 1
20-150	90.6	51.7	36.2	15.4	18	44.5	801.00	3 x 1200 x 800 x 400 mm	Type 2
20-160	105.0	60.8	41.3	17.8	18	55.0	990.00	6 x 1200 x 800 x 400 mm	Type 3
20-200	120.0	68.9	49.1	20.7	18	65.0	1170.00	6 x 1200 x 800 x 400 mm	Type 3
20-230	144.0	80.0	55.2	24.1	18	73.5	1323.00	6 x 1200 x 800 x 400 mm	Type 4

Note: The ageing factor of 25% for the batteries is not considered for the discharge current values.

Table 2

Battery type, charging current, ventilation requirements. charging time 12 hours / 80%.

Battery type	No. of required chargers						Minimum airflow	Ventilation	Free air volume
	1h-discharge		3h-discharge		8h-discharge				
C ₁₀ -1.8V/Z	3A	7A	3A	7A	3A	7A	[m ³ /h]	[cm ²]	[m ³]
20-12	1		1		1		0.06	1.7	0.2
20-18	1		1		1		0.10	2.8	0.3
20-28	1		1		1		0.15	4.2	0.4
20-33	1		1		1		0.18	5.1	0.5
20-40	1		1		1		0.22	6.2	0.6
20-55	1		1		1		0.30	8.4	0.8
20-70	1			1		1	0.38	10.7	1.0
20-70-1		1		1		1	0.38	10.7	1.0
20-80		1		1		1	0.43	12.1	1.1
20-90		1		1		1	0.49	13.8	1.3
20-100		1		1		1	0.54	15.2	1.4
20-135		1		1	1	1	0.73	20.5	1.9
20-120		1		1	1	1	0.65	18.2	1.7
20-150		1		1	1	1	0.81	22.7	2.1
20-160		1	1	1	1	1	0.86	24.1	2.2
20-200	1	1	1	1		2	1.08	30.3	2.7
20-230	1	1		2		2	1.24	34.8	3.1

Planning guide

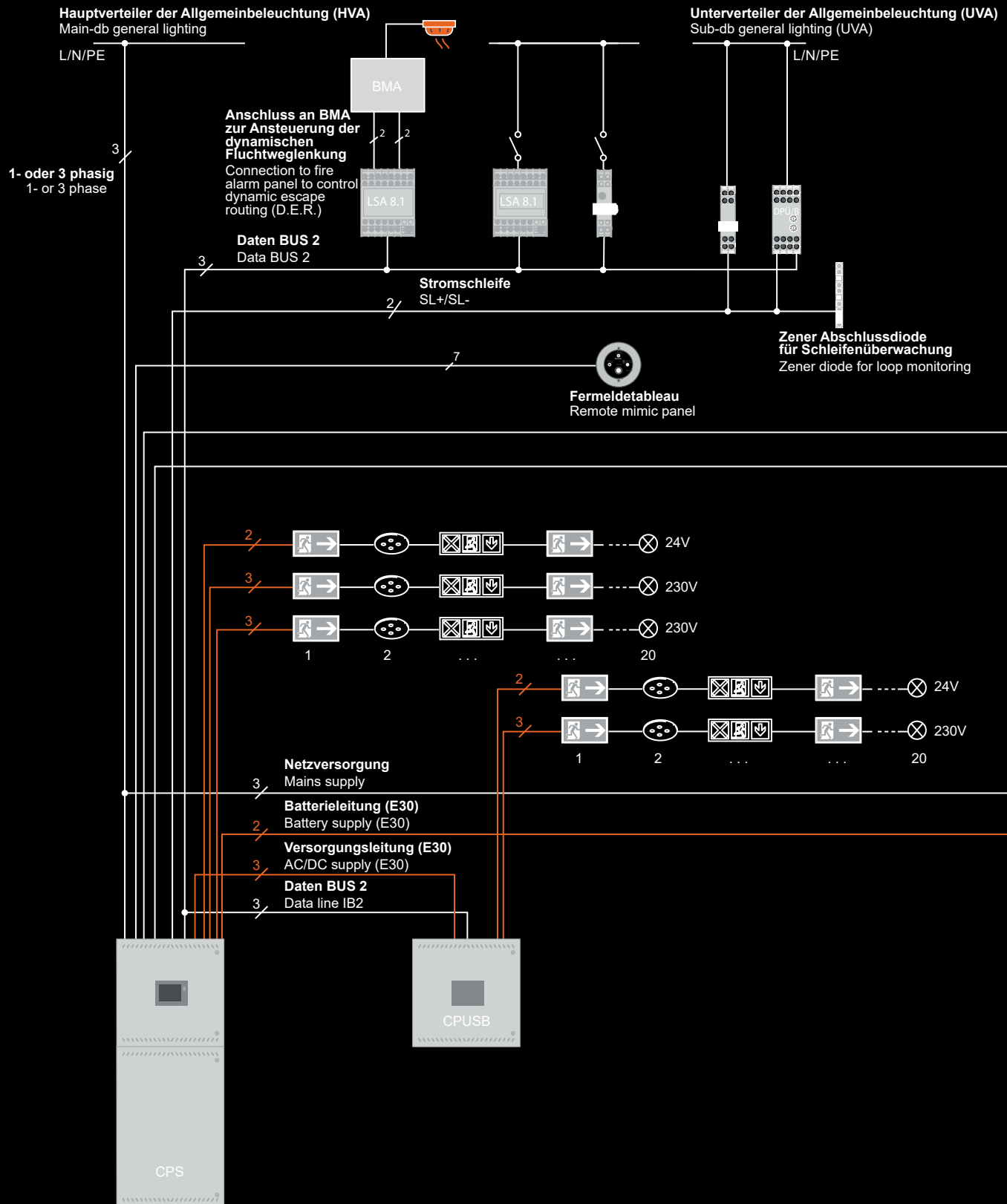

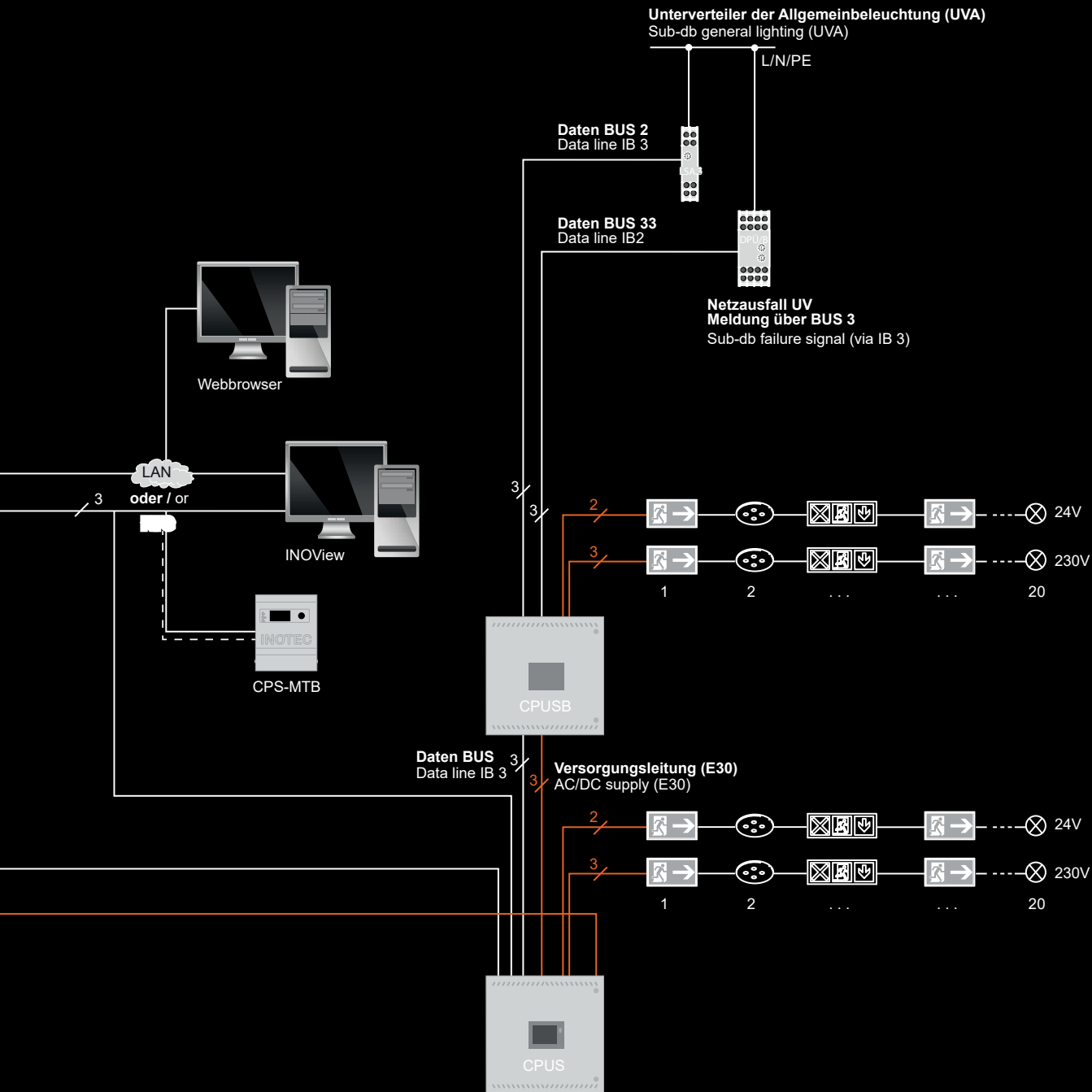

Technical data:	CPS 220/64/11kW-1 1-ph	CPS 220/64/11kW-2 1-ph	CPS 220/64/11kW-1 3-ph	CPS 220/64/11kW 3-ph
<p>Protection class: I Protection category: IP 20 Permitted ambient temperature: System: -5°C to +35°C, max. 85% relative humidity, non-condensing Battery: acc. battery data sheet Battery: 216 VDC Colour: RAL 7035 Base frame (optional): 100mm / 200mm</p>				
Rated voltage	1~N/PE, 230V AC ±10% 50Hz / 60Hz ±2%	1~N/PE, 230V AC ±10% 50Hz / 60Hz ±2%	3~N/PE, 400V AC ±10% 50Hz / 60Hz ±2%	3~N/PE, 400V AC ±10% 50Hz / 60Hz ±2%
System current: Internal	50A	50A	50A	50A
Total	50A	50A	50A	50A
max. Load	11kW	11kW	11kW	11kW
Circuit modules, max. intern/extern 4x2A, 2x4A, 1x6A, 2x2,5A D.E.R.	16 / 16	16 / 16	16 / 16	16 / 16
2x2,5A 24V max. intern/extern	8 / 16	8 / 16	8 / 16	8 / 16
max. installed battery capacity	75Ah	75Ah	75Ah	-
Charger	1 x 3A or 7A	2 x 3A or 7A	1 x 3A or 7A	max. 4 x 3A or 7A
Space for options	2 x 12 DU	3 x 12 DU	3 x 12 DU	30 DU
- with function preservation	2 x 12 DU	-	-	-
Conductor cross section, max. (mm²)				
Mains supply	35	35	35	35
Battery supply	35	35	35	35
Outgoing to luminaries	4	4	4	4
Outgoing data line (RTG)	4	4	4	4
Outgoing BUS IB2/IB3	4	4	4	4
Outgoing 24V monitoring	4	4	4	4
Outgoing mains to CPUS	35	35	35	35
Outgoing battery to CPUS	35	35	35	35
Outgoing supply to CPUSB	35	35	35	35
Dimensions: H x W x D (mm)	2030 x 800 x 400	2230 x 800 x 400	2230 x 800 x 400	2030 x 800 x 400
With function preservation (option)	BRS 10.1	-	-	-
- with fire preservation	2346 x 894 x 586	-	-	-
Cable inlets	slide cover free inlet or	slide cover free inlet or	slide cover free inlet or	slide cover free inlet or
	22 x M20 / 64 x M25 6 x M32 / 2 x M50 depending on the design	22 x M20 / 64 x M25 6 x M32 / 2 x M50 depending on the design	22 x M20 / 64 x M25 6 x M32 / 2 x M50 depending on the design	22 x M20 / 64 x M25 6 x M32 / 2 x M50 depending on the design

*1 max. 55Ah Battery

	CPS 220/64/22kW 3-ph	CPS 220/20/1,2A	CPS 220/20/3A	CPS 220/20/5,5kW/3A	CPS 220/20/5,5kW-1 1-ph
	3~N/PE, 400V AC ±10% 50Hz / 60Hz ±2%	1~N/PE, 230V AC ±10% 50Hz / 60Hz ±2%	1~N/PE, 230V AC ±10% 50Hz / 60Hz ±2%	1~N/PE, 230V AC ±10% 50Hz / 60Hz ±2%	1~N/PE, 230V AC ±10% 50Hz / 60Hz ±2%
	63A	7A	7A	25A	25A
	100A	7A	7A	25A	25A
	22kW	1,5kW	1,5kW	5,5kW	5,5kW
	16 / 16	5 / -	5 / -	5 / 16	5 / 16
	8 / 16	2 / -	2 / -	2 / 16	2 / 16
	-	18Ah	28Ah	28Ah	75Ah
	max. 4 x 3A or 7A	1,2A	3A	3A	1 x 3A or 7A
	24 DU	5 DU	5 DU	7 DU	2 x 12 DU
	-	6 DU	10 DU	10 DU	2 x 12 DU
	35	10	10	10	35
	35	35	35	35	35
	4	4	4	4	4
	4	4	4	4	4
	4	4	4	4	4
	4	4	4	4	4
	4	4	4	4	4
	35	-	-	35	35
	35	-	-	35	35
	35	-	-	35	35
	2030 x 800 x 400	1600 x 600 x 330	1800 x 600 x 330	1800 x 600 x 330	2030 x 800 x 400
	-	BRS 31 / BRS 10.1	BRS 32 / BRS 10.1	BRS 32 / BRS 10.1	BRS 10.1*1
	-	2346 x 894 x 586 (BRS 10.1) 1368 x 668 x 496 (BRS 31)	2346 x 894 x 586 (BRS 10.1) 2066 x 766 x 618 (BRS 32)	2346 x 894 x 586 (BRS 10.1) 2066 x 766 x 618 (BRS 32)	2346 x 894 x 586
	slide cover free inlet or	10 x M20	10 x M20	10 x M20	slide cover free inlet or
	22 x M20 / 64 x M25 6 x M32 / 2 x M50 depending on the design	7 x M20 / 30 x M25 4 x M32	7 x M20 / 30 x M25 4 x M32	7 x M20 / 30 x M25 4 x M32	22 x M20 / 64 x M25 6 x M32 / 2 x M50 depending on the design



*1 max. 55Ah Battery

	CPUS 220/64/11kW	CPUSB 220/64/16	CPUSB 220/64/8-1	CPUSB 220/ 64/1 - 2A	CPUSB 220/64/ 1- 2.5A/24V
Supply voltage	1~N/PE, 230V AC ±10% 50Hz / 60Hz ±2%	230V AC ±10% / 216V DC +10% / -15% (Supplied via main station)			
System current: Internal	50A	50A	50A	8A	5A (24V)
Total	50A	50A	50A	8A	5A (24V)
max. power:	11kW				
Circuit separating module (SKW)		-	-	yes	yes
Slot cards					
4x2A, 2x4A, 1x6A, 2x2.5A D.E.R.	16 / 16	max. 16	max. 8	1 (je 2A o. 4A) (each 2A or 4A)	-
max. internal/external					
2x2.5A 24V max. internal/external	8 / 16	max. 8	max. 4	-	1
Space for options	2 x 12 DU	2 x 12 DU	12 DU	-	-
- at functional preservation	16 DU	20 DU	20 DU	-	-
Max. cross section (mm²) of:					
Supply line / mains	35	35	35	4	4
Battery	35	4	4	4	4
Final circuits	4	4	4	4	4
Data Bus (RTG)	4	-	-	2,5	2,5
Data Bus IB2	4	4	4	4	4
24V current loop	4	-	-	2,5	2,5
Supply line for CPUSB	35				
Dimensions: H x W x D (mm)	830 x 800 x 400	830 x 800 x 400	600 x 600 x 330	378 x 181 x 82	378 x 181 x 82
Functional preservation (optional)	BRS 40	BRS 40	BRS 40	BRS 41	BRS 41
- at functional preservation	1198 x 648 x 449 (BRS 40)	1198 x 648 x 449 (BRS 40)	1198 x 648 x 449	898 x 648 x 449	898 x 648 x 449
Cable inlet	slide cover free inlet or 22 x M20 / 64 x M25 6 x M32 / 2 x M50 depending on the design	slide cover free inlet or 22 x M20 / 64 x M25 6 x M32 / 2 x M50 depending on the design	7 x M20 / 30 x M25 4 x M32	11 x M20	11 x M20

1 DU	2 DU	3 DU	4 DU	5 DU	7 DU
DPÜ	DPÜ / B.2	LSA 3.1 24V, incl. 2 terminals - extension *3, *5	LSA 8.1	LSA 8.1 24V, incl. 4 terminals - extension *3, *5	LSA 8.1 24V, incl. 4 terminals + 24V PSU - basic set *2, *4
LSA 3.1	Fused Neozed for 3-phase connection		RIF 5		
Terminals IB3			BCS		
			Fused output Neozed for BUS-substation		
			Fused output battery Neozed for substation		
			LSA 3.1 24V, incl. 2 terminals + 24V PSU - basic set *2, *4		

*2 First LSA xxx 24V prewired, incl. 24V PSU, for additional use the extension

*3 additional LSA xxx 24V prewired, without 24V PSU, in combination with the basic set

*4 not for use with CPS 220/20 built in compact cabinets (600mm wide)

*5 for use with CPS 220/20 built in compact cabinet (600mm wide)

Microprocessor controlled freely programmable, with non volatile memory TFT touch controller with build in SD-card.

- 5" WVGA touchscreen with intuitive graphical user interface
- Programming, monitoring and control of upto 96 circuits (1920 luminaires)
- Switching modes freely programmable
- Single luminaire monitoring (SV)/circuit monitoring (SKU)
- Programmable automatic function test/battery duration test
- USB interface for uploading/downloading complete system configuration programming, connection of keyboard/PCL-compatible Printer
- Password protection
- Blocking function for complete system/ circuits
- Integrated INOWeb/INOView network interface
- Interface for BMS or other external monitoring systems
- Display of complete status information of the system including battery voltage/ battery current and battery capacity
- Display of failure information for every circuit or individual luminaire incl. destination text info
- Display of charger failure
- Display of voltage and temperature of each individual battery block when using (optional) INOTEC Battery Control System BCS.
- Setting of deep discharge protection and display
- Setting delay on mains return 1-15min
- Log book entries for more than 2 years
- Earth leakage monitor with test and display facility
- Electronically monitored 24V loop for monitoring of any number of sub distribution boards
- Manual reset

CPS - TFT-WVGA-Touch Controller



230V circuit slot card with 4 final circuits for central battery system CPS 220/64 to supply, control and monitor static 230V exit- and safety luminaires.

- Individual slide-in circuit modules with 2 pole fuse-protection for every circuit
- Single luminaire- and circuit- monitoring with JOKER function
- max. 20 luminaire per final circuit
- Monitoring without data-line

Technical data

U_N AC: 230V AC 50/60 Hz

U_N DC: 176-264V DC

Max. current per circuit: 2A

Max. inrush current: 250A / 500µs

Max. power losses: 15W

230V circuit slot card with 2 final circuits for central battery system CPS 220/64 to supply, control and monitor static 230V exit- and safety luminaires.

- Individual slide-in circuit modules with 2 pole fuse-protection for every circuit
- Single luminaire- and circuit- monitoring with JOKER function
- max. 20 luminaire per final circuit
- Monitoring without data-line

Technical data

U_N AC: 230V AC 50/60 Hz

U_N DC: 176-264V DC

Max. current per circuit: 4A

Max. inrush current: 250A / 500µs

Max. power losses: 15W

CP 4x2A

Art. no. 979 002

Final circuit slot card



CP 2x4A

Art. no. 979 004

Final circuit slot card



230V circuit slot card with one final circuits for central battery system CPS 220/64 to supply, control and monitor static 230V exit- and safety luminaires.

- Individual slide-in circuit modules with 2 pole fuse-protection for every circuit
- Single luminaire- and circuit- monitoring with JOKER function
- max. 20 luminaire per final circuit
- Monitoring without data-line

Technical data

U_N AC: 230V AC 50/60 Hz

U_N DC: 176-264V DC

Max. current per circuit: 6A

Max. inrush current: 250A / 500µs

Max. power losses: 15W

CP 1x6A

Art. no. 979 005

Final circuit slot card



230V circuit slot card with 2 final circuits for central battery system CPS 220/64 to supply, control and monitor static 230V exit- and safety luminaires, as well as segment encoder in connection with PSU48 for operating luminaires of the FS-series with running light function.

- Individual slide-in circuit modules with 2 pole fuse-protection for every circuit
- Single luminaire regulation and monitoring
- max. 20 luminaire per final circuit
- 1 common BUS-line for control and monitoring
- Luminaires individually program- and addressable
- Assignment of 8 switching inputs per dynamic escape route luminaire

Technical data

U_N AC: 230V AC 50/60 Hz

U_N DC: 176-264V DC

Max. current per circuit: 2,5A

Max. power losses: 4W

CP 2x2,5A / D.E.R. 230V

Art. no. 979 010

Final circuit slot card



24V Final circuit slot card with 2 final circuit for connection to central battery system CPS 220/64 to supply, control and monitor 24V INOTEC LED-system luminaires. Mixed operation of static and dynamic exit- and safety luminaires at one final circuit.

- 2-pol fuse per circuit
- Single luminaire and circuit monitoring with Joker function
- max. 20 luminaire per final circuit
- monitoring without additional data line
- individual programming, addressing and dimming of each luminaire
- 2 final circuits protection class III (SELV) à 2.5A
- Allocation of 2 switching inputs per exit- or safety luminaire; 8 switching inputs for dynamic escape route luminaires

Technical data

U_N AC: 230V AC 50/60 Hz

U_N DC: 174-264V DC

U_{OUT}: 24V DC +20%

Max. current per circuit: 2,5A

Max. power losses: 20,5W

CP 2x2,5A/24V

Art. no. 979 009



BUS-substation CPUSB with 2 final circuits for connection to central battery system CPS 220/64 to supply, control and monitor static 24V INOTEC LED-system luminaires. Mixed operation of static and dynamic exit- and safety luminaires at one final circuit.

- 2-pol fuse per circuit
- Single luminaire and circuit monitoring with Joker function
- max. 20 luminaire per final circuit
- monitoring without additional data line
- individual programming, addressing and dimming of each luminaire
- 2 final circuits protection class III (SELV) à 2.5A
- Allocation of 2 switching inputs per exit- or safety luminaire; 8 switching inputs for dynamic escape route luminaires
- integrated circuits switch module
- Input for current loop

Technical data

U_N AC: 230V AC 50/60 Hz

U_N DC: 174-264V DC

U_{OUT}: 24V DC +20%

Max. current per circuit: 2,5A

Max. power losses: 20,5W

CPUSB 220/64/1-2x2,5A/24V

Art. no. 922 261

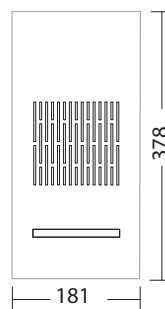

BUS-substation CPUSB with 4 final circuits for connection to central battery system CPS 220/64 to supply, control and monitor static 230V exit- and safety luminaires.

- 2-pol fuse per circuit
- Single luminaire and circuit monitoring with Joker function
- max. 20 luminaire per final circuit
- monitoring without data line
- integrated circuits switch module
- Input for current loop

Technical data

U_N AC:	230V AC 50/60 Hz
U_N DC:	176-264V DC
U_{OUT}:	2A
Max. current per circuit:	250A / 500μs
Max. power losses:	15W

CPUSB 220/64/1-2A

Art.-no. 922 200

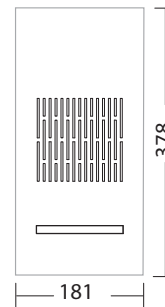

BUS-substation CPUSB with 2 final circuit for connection to central battery system CPS 220/64 to supply, control and monitor static 230V exit- and safety luminaires.

- 2-pol fuse per circuit
- Single luminaire and circuit monitoring with Joker function
- max. 20 luminaire per final circuit
- monitoring without data line
- integrated circuits switch module
- Input for current loop

Technical data

U_N AC:	230V AC 50/60 Hz
U_N DC:	176-264V DC
U_{OUT}:	4A
Max. current per circuit:	250A / 500μs
Max. power losses:	15W

CPUSB 220/64/1-4A

Art.-no. 922 201

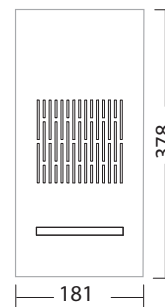

Microprozessor-controlled, modular charger for 230V central battery system with max. 3A charging current in 9', housing. Charging characteristic according to DIN EN 50272-1.

Technical data

UN AC:	220-240V AC 50/60 Hz
U_{OUT} DC:	176 – 264 V DC
Output current:	3A
Efficiency:	90%
cos phi:	0,77
Perm. temperature range:	-15°C ... +45°C
Housing:	Aluminium
Design acc. to:	DIN EN 60146-1-1:2004-04
EMC compatibility:	EN 50081 and EN 50082

Charger 220V / 3A

Art. no. 908 003

Charger



Microprozessor-controlled, modular charger for 230V central battery system with max. 7A charging current in 9', housing. Charging characteristic according to DIN EN 50272-1.

Technical data

UN AC:	220-240V AC 50/60 Hz
U_{OUT} DC:	176 – 264 V DC
Output current:	7A
Efficiency:	92%
cos phi:	0,995
Perm. temperature range:	-15°C ... +45°C
Housing:	Aluminium
Design acc. to:	DIN EN 60146-1-1:2011-04
EMC compatibility:	EN 50081 and EN 50082

Charger 220V / 7A

Art. no. 908 005

Charger



LED-driver for the connection to 230V Low Power or Central Battery Supply systems to supply 1-3 LEDs.
Dimmable in mains supply.
Designed to be fitted inside luminaires.

Technical data

U_N AC:	220-240V AC 50/60 Hz
U_N DC:	176 – 264 V DC
Input current:	55mA
Output current:	const. 320mA +5%
cos Phi:	0,6...0,77
Inrush current:	8A/50µs
Perm. temperature range:	-15°C ... +45°C
Housing:	Polycarbonat
Terminals:	max. 2,5mm ² single-core or 1,5mm ² multi-core with ferrule

J-ET 9/24 SV

Art. no. 860 011

Luminaire module

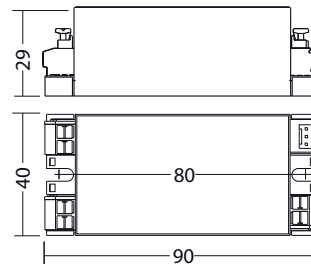

LED-driver for the connection to 230V Low Power or Central Battery Supply systems to supply 1-6 LEDs. Including 230V galvanic isolated sense input for switching with general lighting or as phase monitor. Dimmable in mains supply. Designed to be fitted inside luminaires.

Technical data

U_N AC:	220-240V AC 50/60 Hz
U_N DC:	176 – 264 V DC
Input current:	55mA
Output current:	const. 320mA +5%
cos Phi:	0,6...0,77
Inrush current:	8A/50µs
Perm. temperature range:	-15°C ... +45°C
Housing:	Polycarbonat
Terminals:	max. 2,5mm ² single-core or 1,5mm ² multi-core with ferrule

J-ET 9/24 SV/S

Art. no. 860 020

Luminaire module

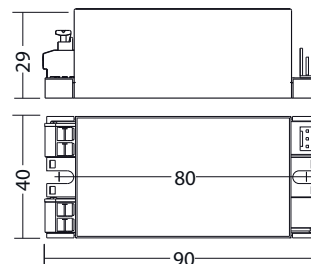

LED-driver for the connection to 230V Low Power or Central Battery Supply systems to supply 1-3 LEDs. Dimmable in mains supply. Designed to be fitted inside luminaires.

Technical data

U_N AC:	220-240V AC 50/60 Hz
U_N DC:	176 – 264 V DC
Input current:	47mA
Output current:	const. 650mA +-5%
cos Phi:	0,81
Inrush current:	8A/50µs
Perm. temperature range:	-15°C ... +50°C
Housing:	Polycarbonat
Terminals:	max. 2,5mm ² single-core or 1,5mm ² multi-core with ferrule

J-ET 7 SV

Art. no. 860 019

Monitoring module

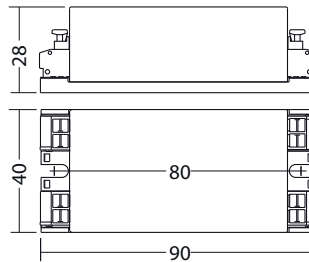

LED-driver for the connection to 230V Low Power or Central Battery Supply systems to supply 1-3 LEDs. Including 230V galvanic isolated sense input for switching with general lighting or as phase monitor. Dimmable in mains supply. Designed to be fitted inside luminaires.

Technical data

U_N AC:	220-240V AC 50/60 Hz
U_N DC:	176 – 264 V DC
Input current:	47mA
Output current:	const. 650mA +-5%
cos Phi:	0,81
Inrush current:	8A/50µs
Perm. temperature range:	-15°C ... +45°C
Housing:	Polycarbonat
Terminals:	max. 2,5mm ² single-core or 1,5mm ² multi-core with ferrule

J-ET 7 SV/S

Art. no. 860 034

Monitoring module

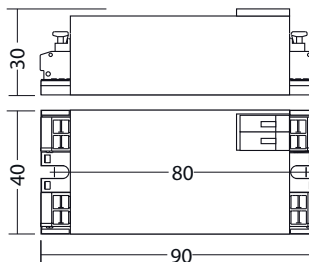

Single lamp monitoring modules for the connection to 230V Low- or Central Power Supply systems. Including 230V galvanic isolated sense input for switching with general lighting or as phase monitor. Designed to be fitted inside luminaires.

Technical data

U_N AC:	220-240V AC 50/60 Hz
U_N DC:	179 – 264 V DC
Inrush current:	2A/40µs
Inrush current of the Monitored luminaire:	80A/500µs
I_{Operation}:	> 20mA
I_{Failure}:	< 10mA
Perm. temperature range:	-15°C ... +65°C
Housing:	Polycarbonat
Terminals:	max. 2,5mm ² single-core or 1,5mm ² multi-core with ferrule

Singel lamp monitoring modules Single lamp monitoring modules for the connection to 230V Low- or Central Power Supply systems. Including 230V galvanic isolated sense input for switching with general lighting or as phase monitor. Designed to be fitted inside luminaires.

Technical data

U_N AC:	220-240V AC 50/60 Hz
U_N DC:	179 – 264 V DC
Inrush current:	2A/40µs
Inrush current of the monitored luminaire:	80A/500µs
I_{Operation}:	> 70mA
I_{Failure}:	< 45mA
Perm. temperature range:	-15°C ... +65°C
Housing:	Polycarbonat
Terminals:	max. 2,5mm ² single-core or 1,5mm ² multi-core with ferrule

J-SV-Modul /S, 5-120W

Art. no. 851 002

Luminaire module

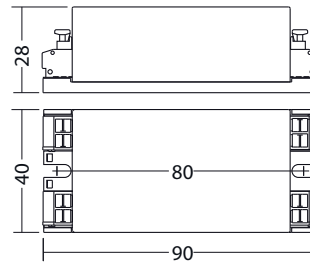

Settings for safe failure identification:

Load	I _{Operation}	I _{Failure}
J-SV-Modul/S	>20 mA	< 10 mA
J-SV-Modul.2/S	>70 mA	< 45 mA
J-SV-Modul.3/S	>12 mA	< 8 mA
J-SV-Modul.4/S	>70 mA	< 45 mA
J-SV-Modul.5/S	>60 mA	< 35 mA
J-SV-Modul L/S	>20 mA	< 10 mA
J-SV-Modul T/S	>60 mA	< 50 mA

J-SV-Modul.2 /S, 20-300W

Art. no. 851 004

Luminaire module

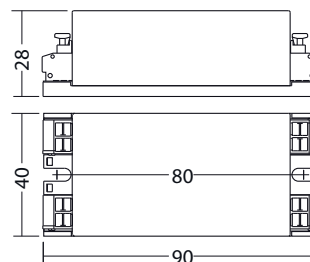

Settings for safe failure identification:

Load	I _{Operation}	I _{Failure}
J-SV-Modul/S	>20 mA	< 10 mA
J-SV-Modul.2/S	>70 mA	< 45 mA
J-SV-Modul.3/S	>12 mA	< 8 mA
J-SV-Modul.4/S	>70 mA	< 45 mA
J-SV-Modul.5/S	>60 mA	< 35 mA
J-SV-Modul L/S	>20 mA	< 10 mA
J-SV-Modul T/S	>60 mA	< 50 mA

Single lamp monitoring modules for the connection to 230V Low- or Central Power Supply systems. Including 230V galvanic isolated sense input for switching with general lighting or as phase monitor. Designed to be fitted inside luminaires.

Technical data

U_N AC:	220-240V AC 50/60 Hz
U_N DC:	179 – 264 V DC
Inrush current:	2A/40µs
Inrush current of the monitored luminaire:	80A/500µs
I_{Operation}:	> 12mA
I_{Failure}:	< 8mA
Perm. temperature range:	-15°C ... +65°C
Housing:	Polycarbonat
Terminals:	max. 2,5mm ² single-core or 1,5mm ² multi-core with ferrule

Single lamp monitoring modules for the connection to 230V Low- or Central Power Supply systems. Including 230V galvanic isolated sense input for switching with general lighting or as phase monitor. Designed to be fitted inside luminaires.

Technical data

U_N AC:	220-240V AC 50/60 Hz
U_N DC:	179 – 264 V DC
Inrush current:	2A/40µs
Inrush current of the monitored luminaire:	80A/500µs
I_{Operation}:	> 70mA
I_{Failure}:	< 45mA
Perm. temperature range:	-15°C ... +65°C
Housing:	Polycarbonat
Terminals:	max. 2,5mm ² single-core or 1,5mm ² multi-core with ferrule

J-SV-Modul.3 /S, 2-30W

Art. no. 851 025

Monitoring module

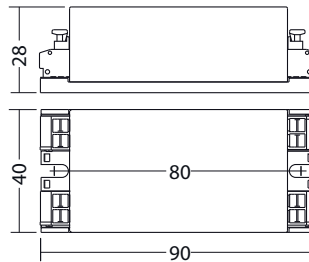

Settings for safe failure identification:

Load	I _{Operation}	I _{Failure}
J-SV-Modul/S	>20 mA	< 10 mA
J-SV-Modul.2/S	>70 mA	< 45 mA
J-SV-Modul.3/S	>12 mA	< 8 mA
J-SV-Modul.4/S	>70 mA	< 45 mA
J-SV-Modul.5/S	>60 mA	< 35 mA
J-SV-Modul L/S	>20 mA	< 10 mA
J-SV-Modul T/S	>60 mA	< 50 mA

J-SV-Modul.4 /S, 18-120W

Art. no. 851 029

Monitoring module

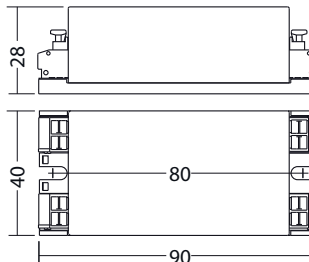

Settings for safe failure identification:

Load	I _{Operation}	I _{Failure}
J-SV-Modul/S	>20 mA	< 10 mA
J-SV-Modul.2/S	>70 mA	< 45 mA
J-SV-Modul.3/S	>12 mA	< 8 mA
J-SV-Modul.4/S	>70 mA	< 45 mA
J-SV-Modul.5/S	>60 mA	< 35 mA
J-SV-Modul L/S	>20 mA	< 10 mA
J-SV-Modul T/S	>60 mA	< 50 mA

Single lamp monitoring modules for the connection to 230V Low- or Central Power Supply systems. Including 230V galvanic isolated sense input for switching with general lighting or as phase monitor. Designed to be fitted inside luminaires.

Technical data

U_N AC:	220-240V AC 50/60 Hz
U_N DC:	179 – 264 V DC
Inrush current:	2A/40µs
Inrush current of the Monitored luminaire:	80A/500µs
I_{Operation}:	> 60mA
I_{Failure}:	< 35mA
Perm. temperature range:	-15°C ... +65°C
Housing:	Polycarbonat
Terminals:	max. 2,5mm ² single-core or 1,5mm ² multi-core with ferrule

Single lamp monitoring modules for the connection to 230V Low- or Central Power Supply systems. Including 230V galvanic isolated sense input for switching with general lighting or as phase monitor. Designed to be fitted inside luminaires.

Technical data

U_N AC:	220-240V AC 50/60 Hz
U_N DC:	179 – 264 V DC
Inrush current:	2A/40µs
Inrush current of the Monitored luminaire:	80A/500µs
I_{Operation}:	> 20mA
I_{Failure}:	< 10mA
Perm. temperature range:	-15°C ... +65°C
Housing:	Polycarbonat
Terminals:	max. 2,5mm ² single-core or 1,5mm ² multi-core with ferrule

J-SV-Modul.5 /S, 15-120W

Luminaire module

Art. no. 851 052

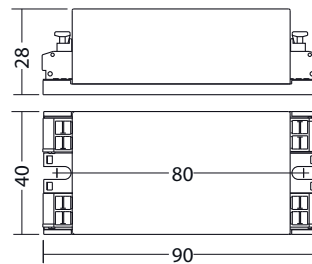

Settings for safe failure identification:

Load	I _{Operation}	I _{Failure}
J-SV-Modul/S	>20 mA	< 10 mA
J-SV-Modul.2/S	>70 mA	< 45 mA
J-SV-Modul.3/S	>12 mA	< 8 mA
J-SV-Modul.4/S	>70 mA	< 45 mA
J-SV-Modul.5/S	>60 mA	< 35 mA
J-SV-Modul L/S	>20 mA	< 10 mA
J-SV-Modul T/S	>60 mA	< 50 mA

J-SV-Modul.L /S, 5-120W

Luminaire module

Art. no. 851 026

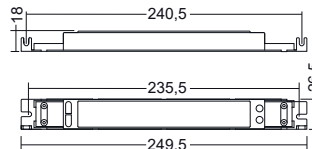

Settings for safe failure identification:

Load	I _{Operation}	I _{Failure}
J-SV-Modul/S	>20 mA	< 10 mA
J-SV-Modul.2/S	>70 mA	< 45 mA
J-SV-Modul.3/S	>12 mA	< 8 mA
J-SV-Modul.4/S	>70 mA	< 45 mA
J-SV-Modul.5/S	>60 mA	< 35 mA
J-SV-Modul L/S	>20 mA	< 10 mA
J-SV-Modul T/S	>60 mA	< 50 mA

Single lamp monitoring modules for the connection to 230V Low- or Central Power Supply systems. Including 230V galvanic isolated sense input for switching with general lighting or as phase monitor. Adjustable emergency operation time with automatic switch-off. Designed to be fitted inside luminaires.

Technical data

U_N AC:	220-240V AC 50/60 Hz
U_N DC:	179 – 264 V DC
Inrush current:	13A/68µs
Inrush current of the monitored luminaire:	40A/500µs
I_{Operation}:	> 60mA
I_{Failure}:	< 50mA
Perm. temperature range:	-15°C ... +50°C
Housing:	Polycarbonat
Terminals:	max. 2,5mm ² single-core or 1,5mm ² multi-core with ferrule

J-SV-Modul.T /S, 20-100W

Art. no. 851 046

Monitoring module

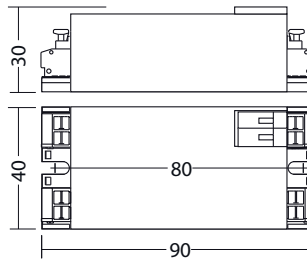

Settings for safe failure identification:

Load	I _{Operation}	I _{Failure}
J-SV-Modul/S	>20 mA	< 10 mA
J-SV-Modul.2/S	>70 mA	< 45 mA
J-SV-Modul.3/S	>12 mA	< 8 mA
J-SV-Modul.4/S	>70 mA	< 45 mA
J-SV-Modul.5/S	>60 mA	< 35 mA
J-SV-Modul L/S	>20 mA	< 10 mA
J-SV-Modul T/S	>60 mA	< 50 mA

For common switching (On/Off) of general and safety luminaires.

The assignment of the luminaires to the light switch application module is done during programming of the controller.

A maximum of 8 LSA3.1 modules can be connected to one controller.

Technical data

Housing:	Thermoplastic V0
Nominal voltage:	230 V AC
Protection category:	II
Protection class:	IP 20
Perm. temperature range:	-15°C ... +40°C
EMC compatibility:	acc. to EN 61000-6-2 / 61000-6-3
Terminals:	2.5mm ² single-core 1.5mm ² multi-core with ferrule

LSA 3.1 / 230V

Art. No. 850 010

DIN rail mounting

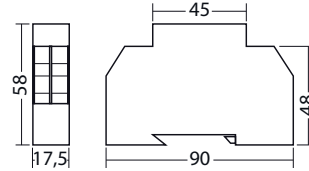

For common switching (On/Off) of general and safety luminaires.

The assignment of the luminaires to the light switch application module is done during programming of the controller.

A maximum of 8 LSA3.1 modules can be connected to one controller.

Technical data

Housing:	Thermoplastic V0
Nominal voltage:	24V DC
Protection category:	III
Protection class:	IP 20
Perm. temperature range:	-15°C ... +40°C
EMC compatibility:	acc. to EN 55015
Terminals:	2.5mm ² single-core 1.5mm ² multi-core with ferrule

LSA 3.1 / 24V

Art. No. 850017

DIN rail mounting

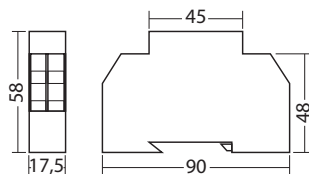

For common switching (On/Off) of mains and safety luminaires and for monitoring of mains voltage.

Channels are galvanically isolated.

The assignment of the luminaires to the light switch application module is done during programming of the controller.

Integrated 3-phase monitoring / BUS:

- Any phase sequence
- Signalling contact / 1 x change-over contact
- Detection of undervoltage and loss of mains
- 1-ph connection possible acc. to IEC 255, VDE 0435, T.303
- Nominal Voltage 230V / 400V AC
- Threshold: $0,85 U_N$
- Deactivateable

A maximum of 3 LSA8.1 modules can be connected to one controller.

Technical data

Housing:	Thermoplastic V0
Nominal voltage:	230V AC
Protection category:	II
Protection class:	IP20
Perm. temperature range:	-15°C ... +40°C
EMC compatibility:	acc. to EN 61000-6-2 / 61000-6-3
Terminals:	2.5mm ² single-core 1.5mm ² multi-core with ferrule

For common switching (On/Off) of mains and safety luminaires and for monitoring of mains voltage.

Channels are galvanically isolated.

The assignment of the luminaires to the light switch application module is done during programming of the controller.

Integrated 3-phase monitoring / BUS:

- Any phase sequence
- Signalling contact / 1 x change-over contact
- Detection of undervoltage and loss of mains
- 1-ph connection possible acc. to IEC 255, VDE 0435, T.303
- Nominal Voltage 230V / 400V AC
- Threshold: $0,85 U_N$
- Deactivateable

A maximum of 3 LSA8.1 modules can be connected to one controller.

Technical data

Housing:	Thermoplastic V0
Nominal voltage:	24V DC
Protection category:	II
Protection class:	IP20
Perm. temperature range:	-15°C ... +40°C
EMC compatibility:	acc. to EN 61000-6-2 / 61000-6-3
Terminals:	2.5mm ² single-core 1.5mm ² multi-core with ferrule

LSA 8.1 / 230V

Art. No. 850 008

DIN rail mounting

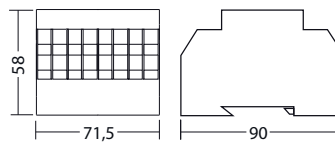

LSA 8.1 / 24V

Art. No. 850 007

DIN rail mounting

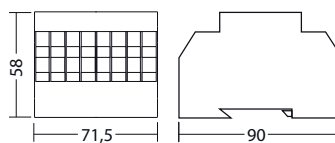

For voltage monitoring of sub distribution boards. Detailed phase failure information and location details in plain text at the controller unit.

Equipped with two voltage-free n/o signalling contacts.

- LED indicators for L1, L2, L3
- Any phase sequence
- Detection of undervoltage and mains failure in three-phase network
- Can also be connected as a 1-phase module according to IEC 255
- Suitable for switchboard mounting on DIN rails.
- Detailed phase failure information and location details in plain text at the emergency lighting central.
- Variable delay time after mains return.

A maximum of 31 DPÜ/B.2 modules can be connected to one controller unit!

Technical data

Housing:	Thermoplastic V0
Nominal voltage:	230V/400V AC 50/60 Hz
Threshold:	0,85 U_N
Protection category:	II
Protection class:	IP20
Perm. temperature range:	-15°C ... +40°C
EMC compatibility:	acc. to EN 61000-6-2 / 61000-6-3
Terminals:	2.5mm ² single-core 1.5mm ² multi-core with ferrule

For voltage monitoring of sub distribution boards.

Equipped with one voltage-free fault signal change-over contact

- LED indicator for L1, L2, L3
- Any phase sequence
- Detection of undervoltage and mains failure at three-phase network
- Can also be connected as a 1-phase module acc. to IEC 255, VDE0435, T.303
- Suitable for switchboard mounting on DIN rails

Technical data

Housing:	Thermoplastic V0
Nominal voltage:	230V/400V AC 50/60 Hz
Threshold:	0,85 U_N
Protection category:	II
Protection class:	IP20
Perm. temperature range:	-20°C ... +40°C
EMC compatibility:	acc. to EN 61000-6-2 / 61000-6-3
Terminals:	2.5mm ² single-core 1.5mm ² multi-core with ferrule

DPÜ/B.2

DIN rail mounting

Art. No. 890 417

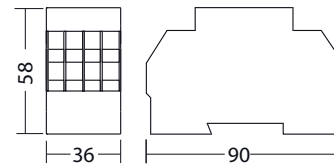

DPÜ

DIN rail mounting

Art. No. 890 400

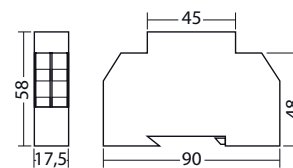

Interface for remote status indication and system blocking function.

- Free programmable, in connection to a switch, for
- maintained and non maintained emergency light ON/OFF
 - maintained emergency light ON/OFF

With or without loop monitoring

5 voltfree contacts for

- operation
- battery operation
- failure (general)
- free programmable 2x

(max. load per contact: 24V/1A)

Terminals battery sensor for temperature controlled charging

With phase monitor (sub-db or main-db), single phase

EMC compatibility acc. to EN 61000-6-2 / 61000-6-3

EMC protected to EN 55015

RIF 5

Art. no. 850 009

DIN rail mounting

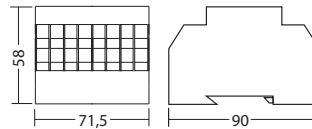

		System status		
		Operation	Sum-failure	Battery operation
Relay contacts	Failure 1-2	close	open	close
	Operation 3-4	close	open	open
	Battery operation 5-6	open	open	close
	Option 1	selectable		
	Option 2	selectable		

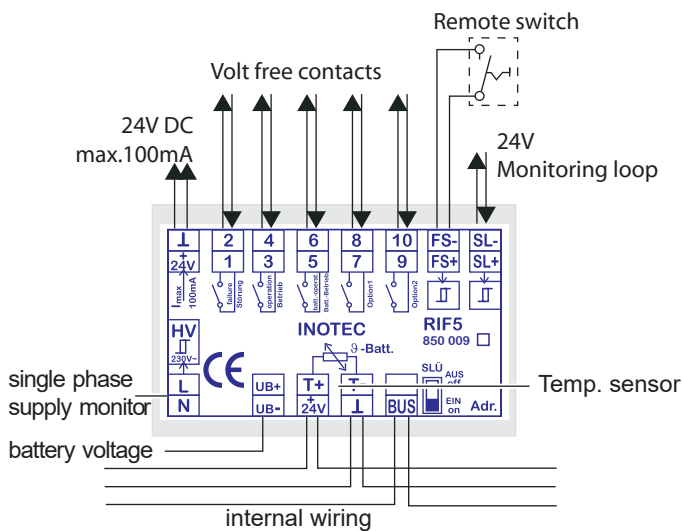

Batterymanagementsystem BCS for monitoring of up to 36 battery blocks. Logging of the individual battery block temperatures and voltages allows a temperature controlled charging and a safety shutdown when limits are exceeded. All RIF5 functionalities are intergrated. Usable only in combination with a TFT controller unit.

Technical data:

Nominal voltage:	24V DC
Perm. temperature range:	-15°C ... +40°C
Housing:	Thermoplastic V0
Terminals:	2,5mm ² single-core or 1,5mm ² multi-core with ferrule
EMC compatibility:	acc. to DIN EN 55015
Protection class:	I
Protection category:	IP20
Max. Sensors:	36

BCS

Art. no. 990 101

Battery monitoring module

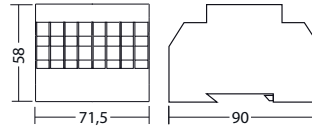

BCS sensor for monitoring of battery block voltage and temperature.

Technical data:

Nominal voltage:	7-20V DC
Power consumption:	1,1mA Standby-Modus 1,5mA query mode
Perm. temperature range:	-10°C ... +95°C
Housing:	Thermoplastic V0
EMC compatibility:	acc. to DIN EN 55015
Protection class:	III
Protection category:	IP20

BCS Sensor

Art. no. 990 100



CPS FUSION-MTB

External status and fault indication down to luminaire level of up to 16 connected CPS FUSION systems via three-core RTG bus.

Central initiation of manual and automatic function and duration tests at freely definable time intervals.

The status of the emergency lighting systems is indicated by 3 Status-LEDs and on the OLED graphic display in clear text or acoustically indicated by an integrated buzzer.

Function indicators:

- Green LED – operation
- Yellow LED – Battery operation
- Red LED – Fault (general)

Additional status indication by 4 potential-free contacts:

- Operation
- Battery operation
- Fault
- Free programmable

Terminals for circuit loop in order to block/release the connected emergency lighting systems.

Technical data

Nominal voltage: 230V AC +/- 10%
24V DC +/- 20% (optional)

Perm. temperature range: -5°C bis +30°C

Protection category: I

Protection class: IP 20

CPS FUSION-MTB

Wall mounting

Art. No. 972 400V

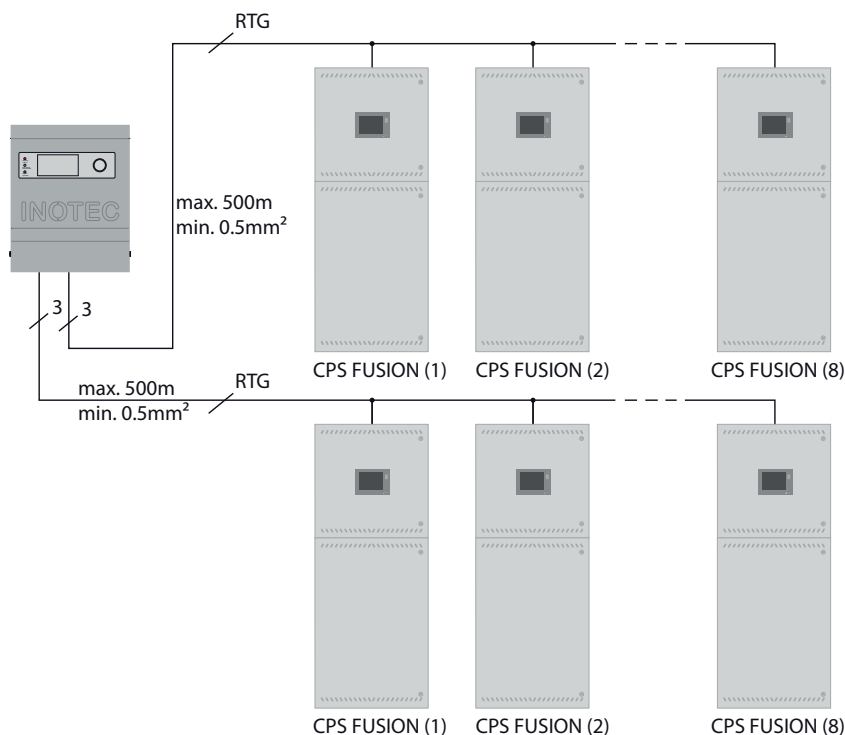
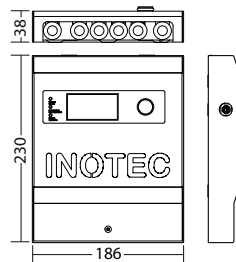

MTB

The MTB-Mimic panels (MTB/AP = wall mounting, MTB/UP = switchboard/recessed wall mounting) are used to display status and fault messages of emergency lighting systems.

With the integrated key-switch, the system can be blocked.

Functions:

Key-switch programmable for

- Emergency and maintained light ON/OFF
- Maintained light ON/OFF

Function indicators:

- Green LED – operation
- Yellow LED – Battery operation
- Red LED – Fault (general)

Connection to relay contacts of a CPS FUSION; maximum wire length with a cross-section of 0.5mm²: 500m

Technical data

- Nominal voltage:** U_N= 24V DC +/-10%
- Operating mode:** Continuous operation
- Perm. temperature range:** -15°C bis +40°C
- Protection class:** IP30
- Housing:** Stainless steel cover/Polycarbonate
- EMC compatibility:** acc. to DIN EN 55015

Logbook

For emergency and safety lighting systems in DIN A4 folder format.

Including templates for commissioning, tests, inspections and maintenance as well as information related to the German regulations, which are currently valid.

The back of folder can be labelled with specific project and system information.

Includes 64 pages and 11 register.

MTB/AP

Art. No. 990 097

Wall mounting

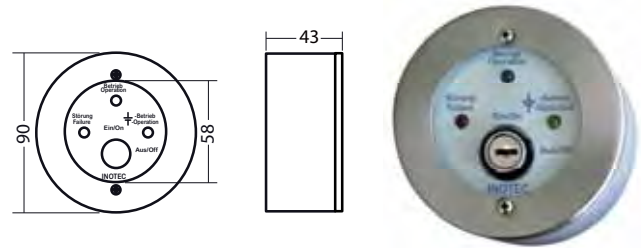

MTB/UP

Art. No. 990 039

Recessed wall mounting

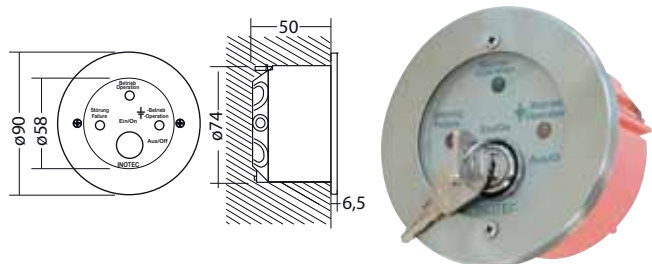

Logbook

Art. No. 708 059

Documentation





INOView - Central Monitoring for Emergency Lighting

INOView is the central visualisation solution for all INOTEC emergency lighting systems. All information on the connected systems can be called up in an intuitive interface. Due to its open architecture and multi-user capability, the software is suitable for all project sizes.

Advantages

- Central logbook
- Detailed fault information down to luminaire level
- Multi-user operation
- Access authorisation
- E-mail Client
- Client-Server-operation
- Floor plan visualisation
- Monitoring of all INOTEC emergency lighting systems

Applications

- Public buildings
- Industry
- Hotels
- Offices
- Meeting places
- Sales premises



INOView - A new perspective

Emergency and safety lighting is used to ensure people's safety in buildings in the event of a power failure or fire. It is essential that the safety equipment is tested, maintained and monitored in accordance with the applicable standards to ensure that this is the case in the event of such an emergency. The results must be recorded accordingly.

The INOView monitoring software from INOTEC supports you to achieve this. A solution that offers a multitude of possibilities, reacts flexibly to the requirements and enables a standard-compliant verification of the system states through the integrated test book.

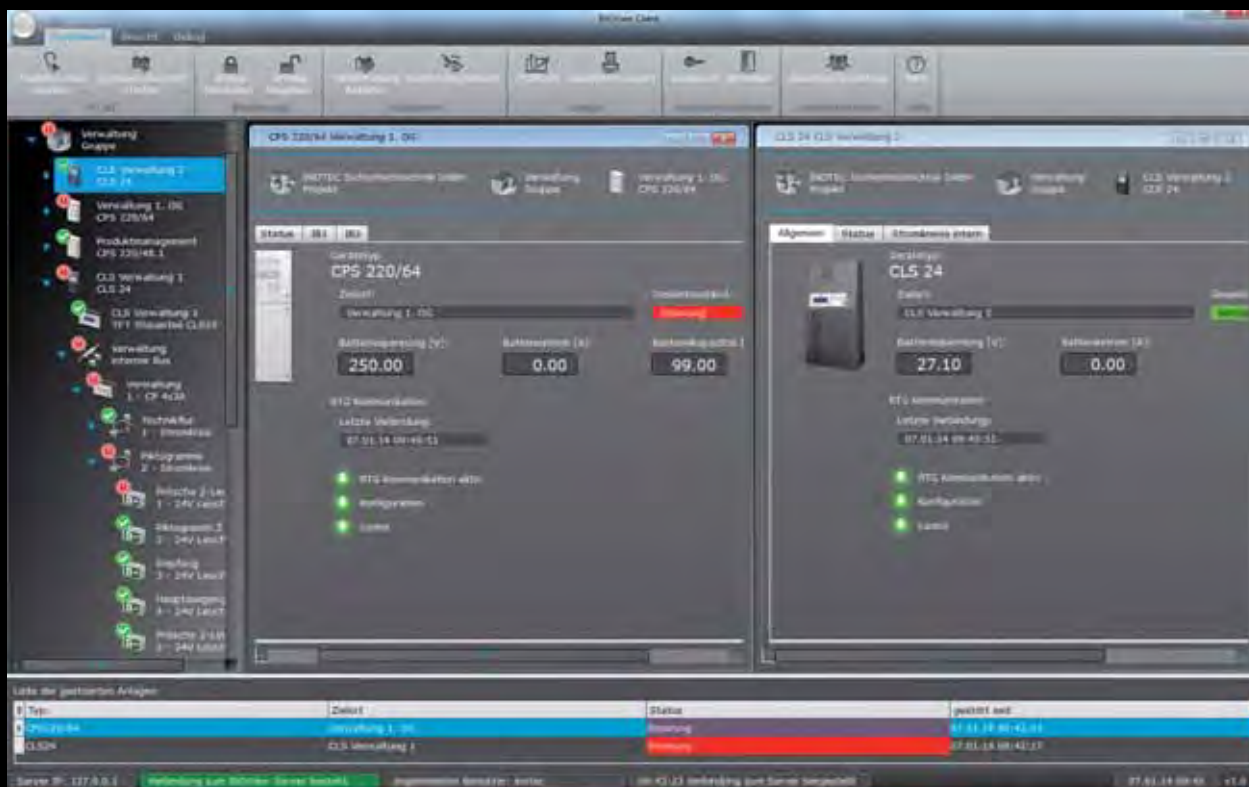

- ▶ Monitoring of INOTEC emergency lighting systems CPS 220/64, CPS 220/48.1, CPS 220/20, CPS 220/48, CLS 24, CLS 24.1, NEA-ICU, NEA, BNS-MTB, LPS24, ELS, CLS FUSION, CPS FUSION, DER 220
- ▶ Connection of the devices via network or/and INOTEC RTG-BUS
- ▶ Failure information down to luminaire level with destination texts
- ▶ Logbook
- ▶ Message window of faulty devices
- ▶ Group functionality
- ▶ Automatic function and duration test programable at project, group and device level
- ▶ Simultaneous display of multiple detail views
- ▶ Multilinguality
- ▶ Access authorisation
- ▶ Multi-user operation
- ▶ Client-Server operation
- ▶ Email notification at status changes
- ▶ Floor plan visualisation

Everything at a glance for personal safety in buildings

The user was in the focus of the development of the visualisation software INOView. It is important to provide simple, intuitive user guidance and transparency through clearly structured system images and clear texts. At just one view, the user recognises the overall status of the safety lighting system and may quickly initiate measures to guarantee personal safety in the building.

The INOView software ensures transparency and provides the user with comprehensive and detailed information about the systems.

Modern Client-/Server – architecture

A modern client/server architecture creates future and investment security. From the clients, several users in the network can simultaneously access the information of the INOView software. An integrated user administration protects the software from unauthorised access.



Adaptive

Every project is structured individually and has different requirements. You can configure the INOView software to meet your requirements and wishes. The integrated grouping option allows you to structure projects according to your preferences. For example, you can define locations, buildings or responsibilities as a group in which you assign the monitored emergency lighting systems.

Automatic tests

With automatic tests, the INOView software simplifies the tests and maintenance required by the standards and thus improves the availability of emergency and safety lighting. You can freely define the tests for each device, group or overall project.

Powerful and easy to use

With the INOView software, you have your emergency lighting systems clearly and safely "under control". Intuitive operating menus enable simple and convenient operation. Individually configurable visualisations of the information ensure transparency. The software grows with the size of the project. Whether a school or an airport, the INOView software is adapted to the customer's requirements with modern standards.

Overview of benefits

- ▶ Easy to use
- ▶ Transparency
- ▶ Adaptable, flexible and expandable
- ▶ Modern software architecture

Installation examples

Client and server components are installed on a PC. The connection of the monitored systems is made via USB or a serial interface for INOTEC RTG-BUS systems or via network connections for devices with a network interface. Access is only from this PC, no network access is provided.

Using the three-core INOTEC RTG-BUS, a free topology with a maximum overall length of up to 500m is possible. The device types can be mixed within one line.

Application examples: Schools, retirement homes, multi-storey car parks, theatres, cinemas, small industrial companies, etc...

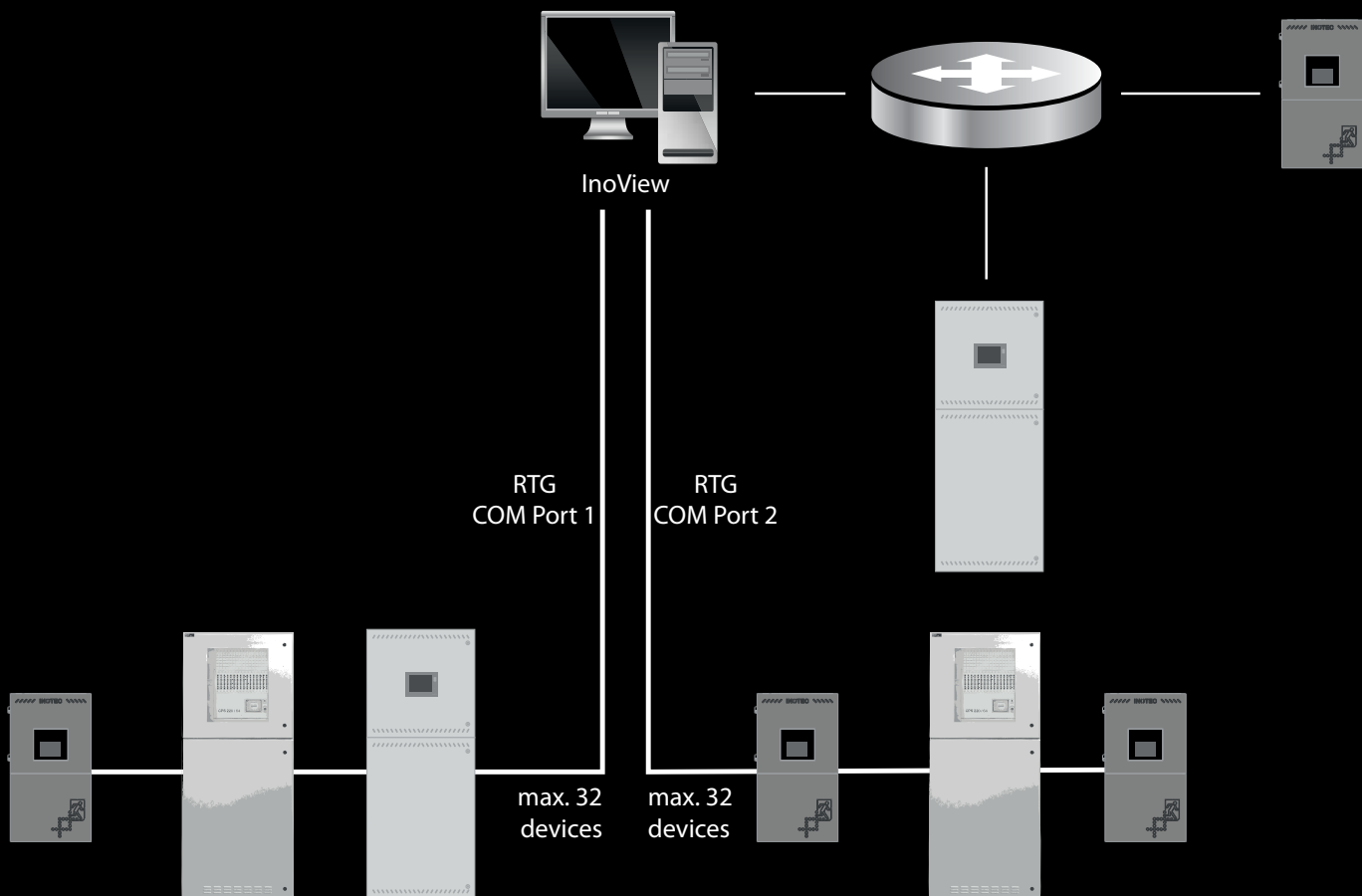

The INOView server is installed on a physical or virtual server, the users get access via client software at their workstation. Several users can work simultaneously with this installation in the network. Several interfaces for monitoring via INOTEC RTG-BUS are connected to the server, further devices are monitored simultaneously by network.

A multi-location monitoring is possible with a company network. This is interesting for industrial or logistics companies with several locations that prefer centralised monitoring, but for example also for the public sector with a central technician who is responsible for several schools.

Using the three-core INOTEC RTG-BUS, a free topology with a maximum overall length of up to 500m is possible. The device types can be mixed within one line.

Application examples: Public sector, clinics, industrial companies, airports, logistics centres, etc.

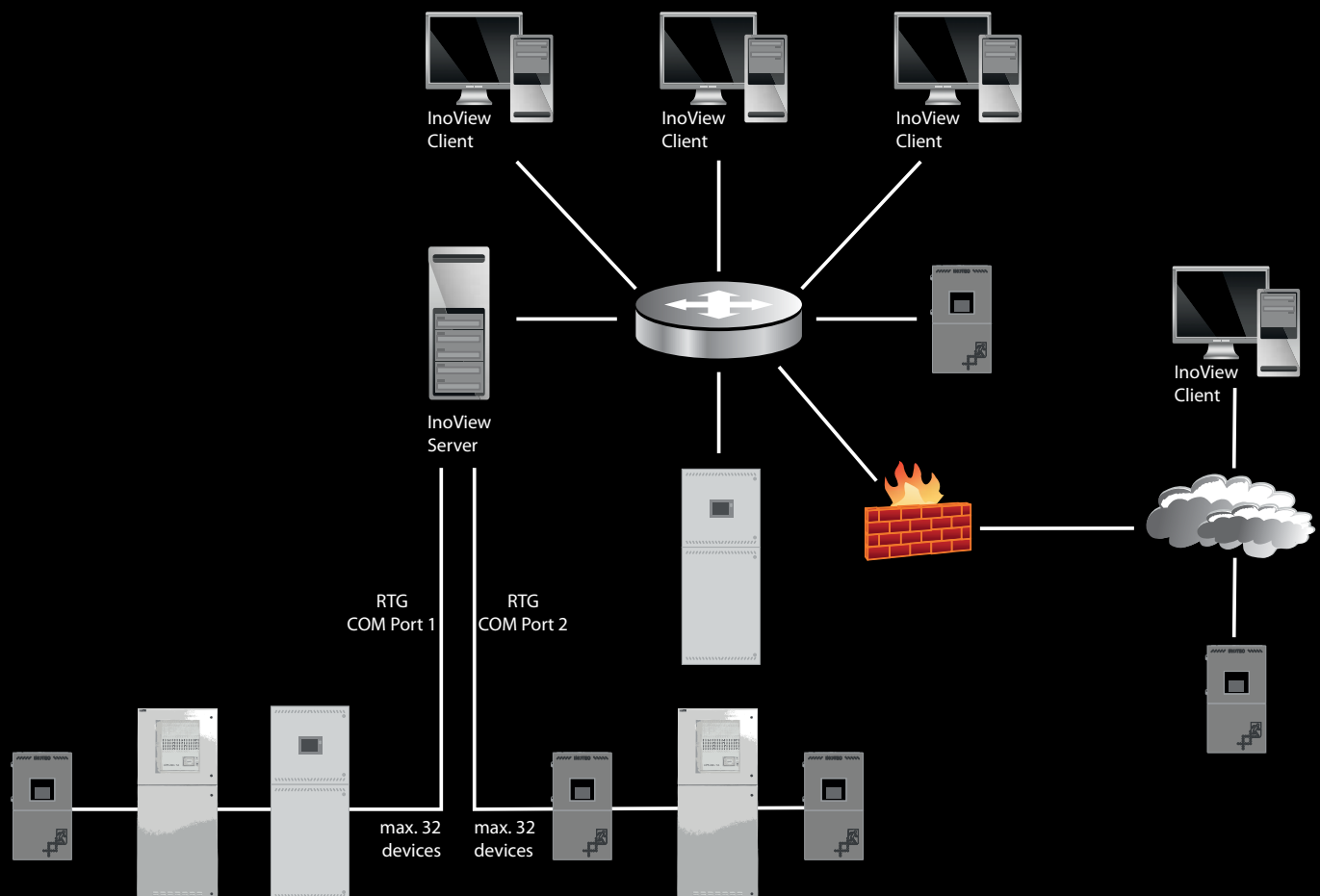

Overview of the user interface

Clear and easy to use

The individually adaptable user interface enables quick fault localisation. The central element of operation is the detailed view. On the left tree view the entry is selected for display the detail view. Several detail views can be opened in parallel with the INOView software.

For example, the status of a central battery device can be displayed in one detailed view and battery information can be displayed in another.

The right mouse button activates a context menu with further functions.

A list of the faulty systems immediately shows where action is required. A double-click opens the corresponding emergency lighting system in the detailed view.

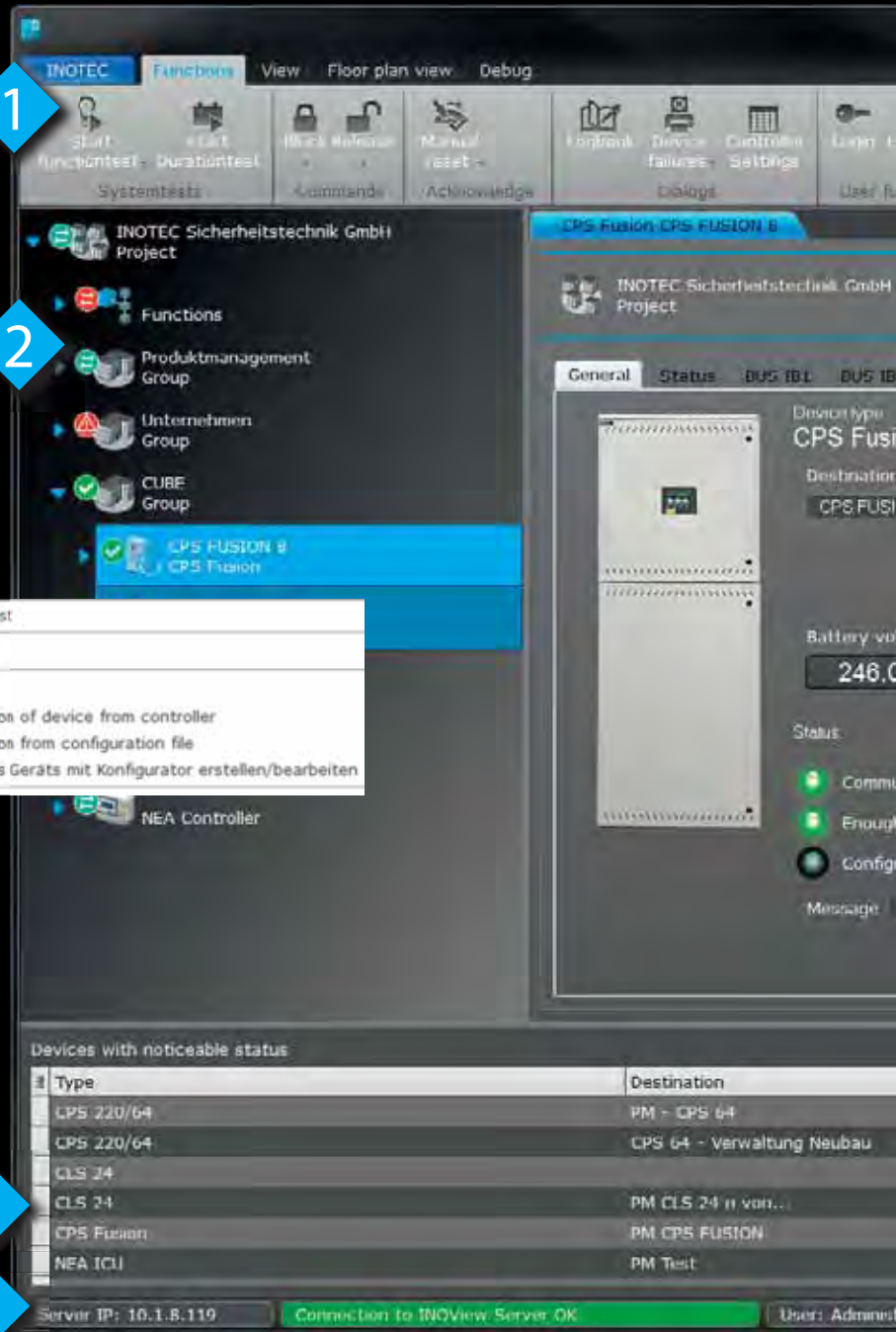

- 1 Menu bar
- 2 Tree view of the activated emergency lighting systems
- 3 Open detail views
- 4 Detail view
- 5 List of faulty emergency lighting systems
- 6 Status bar
- 7 Context menu
- 8 Navigation path
- 9 System status



Devices with noticeable status

Type	Destination
CPS 220/64	PM - CPS 64
CPS 220/64	CPS 64 - Verwaltung Neubau
CLS 24	
CLS 24	PM CLS 24 II von...
CPS Fusion	PM CPS FUSION
NEA ICI	PM Test

Server IP: 10.1.8.119 Connection to INOView Server OK User: Admin

The screenshot shows the INView Client interface. At the top, there is a navigation bar with icons for Logout, User administration, RCS View, Settings, and Help. Below this is a section for 'Special functions' with icons for CUBE Group and CPS FUSION 8 CPS Fusion. The main area displays 'Total status' as 'Operation' with a green progress bar. Below this, there are three data fields: 'Battery current [A]' showing 0.00, and 'Battery capacity [%]' showing 100.00. A 'Configuration download' button is visible. At the bottom, a table lists system events with columns for 'Status' and 'Faulty since'.

Status	Faulty since
Blocked	13.06.2019 08:05
1ao failure	12.06.2019 10:22
Failure	12.06.2019 10:22
Offline	12.06.2019 10:22
Offline	12.06.2019 10:22
Failure	13.06.2019 01:00

Floor plan visualisation

To quickly locate defective luminaires, it is possible to visualise them in a floor plan with their status. One floor plan can be stored per circuit. The vector graphics are based on files in Scalable Vector Graphics Format (SVG), which can be exported from common CAD programs.

The luminaires will be imported from the luminaire database by drag & drop, scaled and aligned.

It is also possible to print out the floor plan with the luminaire status.

The module "floor plan visualisation" is optional.



- 1 Position and status of the luminaires.
- 2 Luminaire container for placing into the floor plan
- 3 Faulty emergency luminaire
- 4 Import floor plans
- 5 Printout of the displayed floor plan view

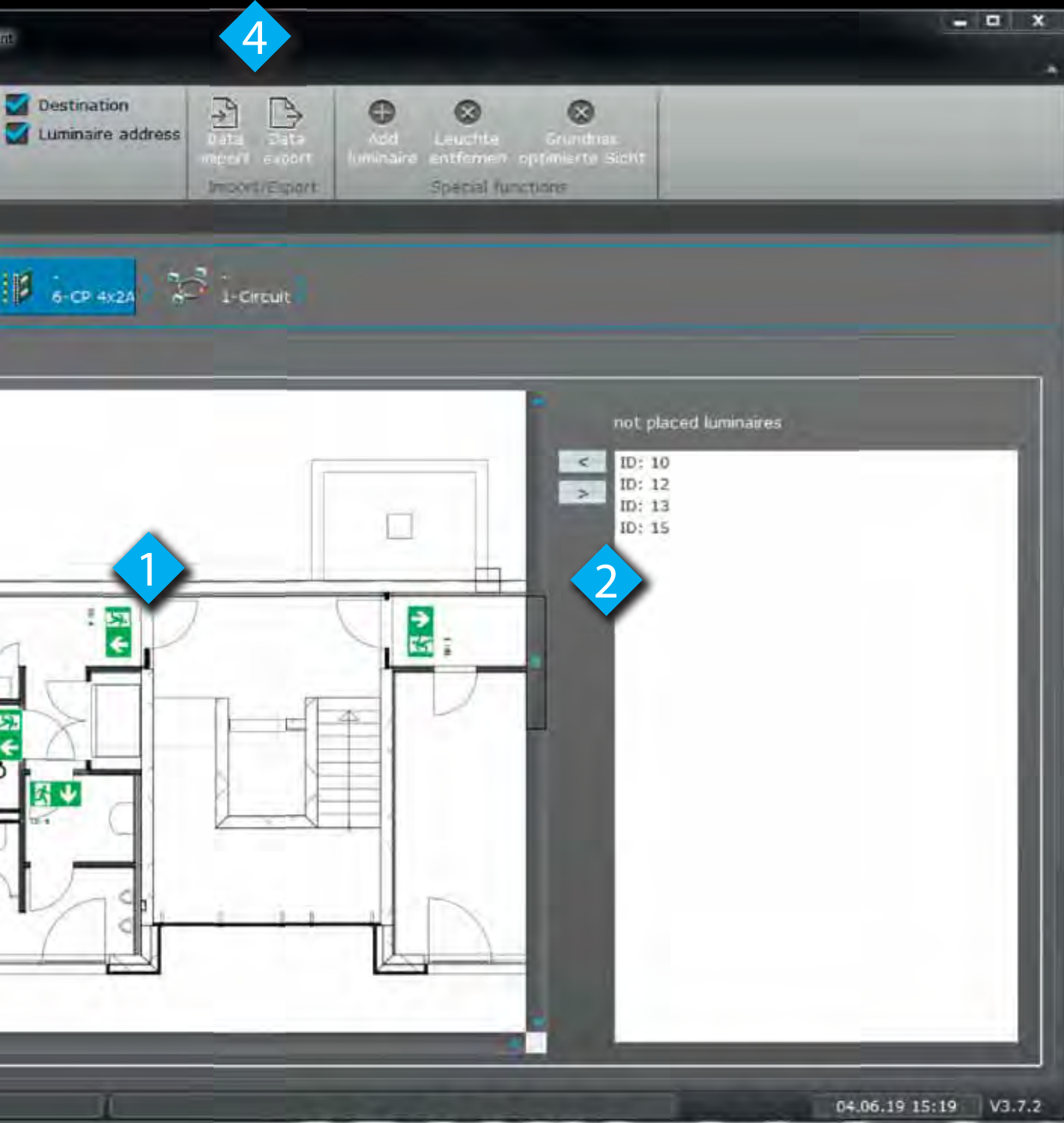

Analysis, log book, fault overview



Simultaneous display of several detail views.



Freely definable table views. Double-click on an entry to navigate to it.

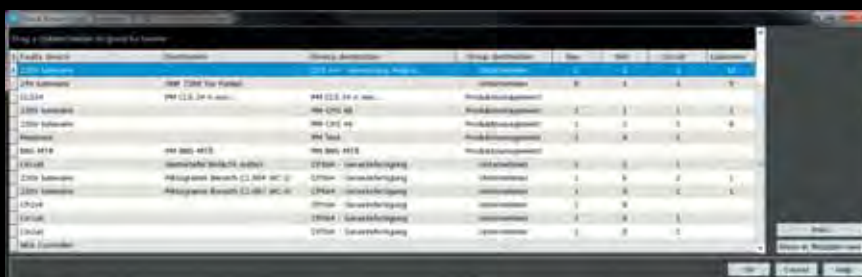

All faults are displayed in the Device faults dialog. A double-click opens the corresponding fault in the detailed view - a quick and easy troubleshooting.



Clear logbook view with filter function. The entries can be filtered freely in the table. Output to a printer is also possible.



The entries in the tables can be grouped or filtered several times using the existing columns. For example, the entries can be grouped by destination of the device and event. Thus a simplified failure analysis is possible.



Further information can be accessed from the detailed view. Individual luminaire faults are displayed with destination information and can be exported to a printer.

INOView Battery monitoring

Mit Integration des Battery Control Systems (BCS) zur Überwachung jedes einzelnen Batterieblocks in die INOView-Software, ist eine genaue Analyse der aufgezeichneten Daten möglich.

Diagrams visualise very clearly the state of the block voltage and temperature of the battery blocks. The BCS system logs the measurement data daily and from each duration test. The BCSView software, which can be accessed directly from the INOView software, is used to display the information.

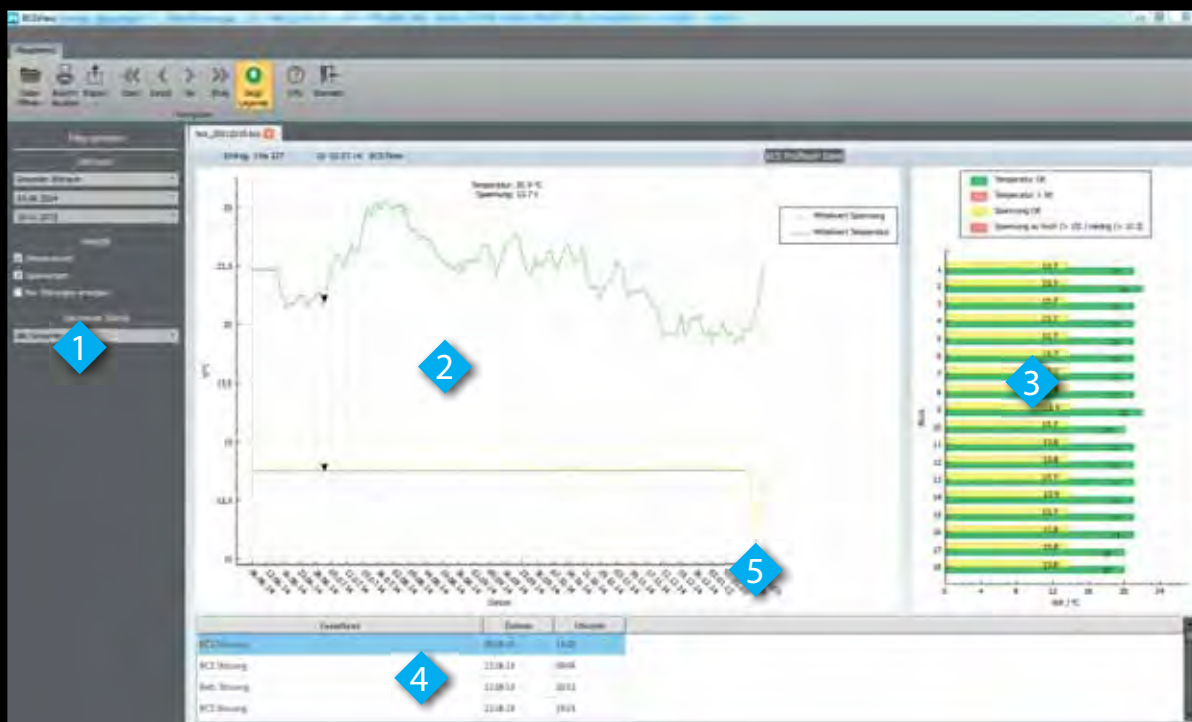

User Interface Overview

- 1 Filter functions
- 2 Battery block temperature / voltage within a time period
- 3 Display of the individual values at a specific period of time
- 4 Table with special events
- 5 Voltage drop of the battery blocks

For use with the INOView software, the supported systems must be connected via a network.

INOView E-Mail notification

The integrated e-mail function automatically notifies recipients in the event of a fault, power failure or after a function test.



The recipients receive an e-mail with the necessary information and can immediately decide how quickly a response is required.

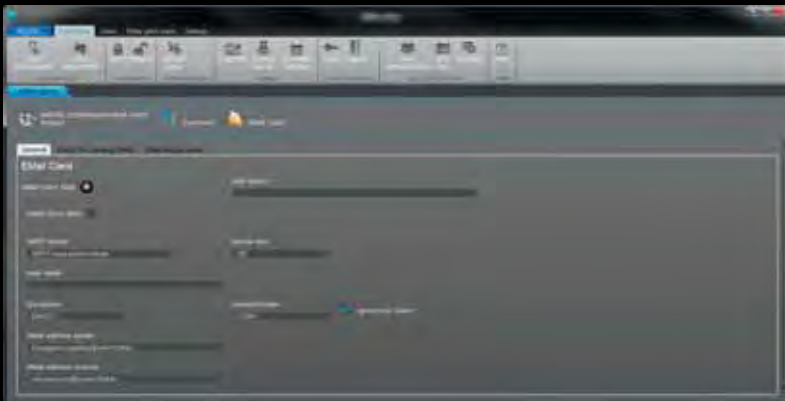

An SMTP server is required for e-mail functionality.

The INOView software also supports e-mail servers with authentication.

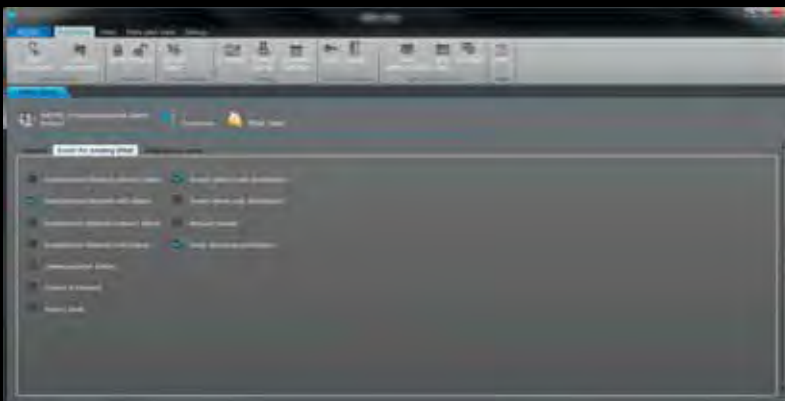

It can be defined exactly after which event a notification is sent by e-mail. Alternatively, a mail can be sent daily at a specified time across all devices with an abnormal status.

Everywhere in use

INOView supports you in all aspects of ensuring personal safety and simplifies the maintenance and care of emergency and safety lighting.

Schools & Universities

Every day there are hundreds or even thousands of people in schools and universities. Safety must always be guaranteed during operating hours, making continuous monitoring of emergency and safety lighting necessary. Since these complexes usually extend over several buildings, a central administration optimises the tasks of the technician using INOView software.

In order to prevent battery discharge during downtimes and to reduce operating costs, the emergency lighting systems can be blocked centrally and corresponding areas can be reactivated for evening events.

Transport & Traffic

Whether airports or railway stations, there are a large number of travellers around the clock. A panic can quickly break out in the event of danger or an emergency. Emergency and safety lighting must function to ensure that people can leave the building safely.

In such objects there are several thousand light points, a central control and maintenance point must keep the overview. INOView shows its strength with its clear structure especially in such projects. The individual grouping options and a clear overview of the existing faults with filter options support you in your daily work.

Public buildings, theatres & meeting places

Non-local people stay in public buildings, theatres and meeting places every day. In an emergency, these people must immediately recognise how to leave the buildings safely.

INOView is your tool to simplify the maintenance and care of emergency and safety lighting and ensure safety in the building.

Logistics & Industry

A central electrical service centre has to take care of the maintenance of several buildings and sites in the logistics and industrial sector. This requires a lot of time. The central monitoring system INOView supports you with important information and clearly structured messages to reduce your workload. Building complexes or locations can be usefully combined using the freely definable groups. Regardless of the device type, you can see in which area a fault is present.



Visualisation software INOView, for centralised remote monitoring of INOTEC emergency lighting systems. The client-/server- architecture allows access of multiple PCs within the network. The essential version of INOView includes logbook, failure information, automatic tests and 10 system credits for INOTEC emergency lighting systems.

System requirements

Server:

Operating system: Microsoft Windows 7, Windows 2008 Server, Windows 2012 Server, Windows 10
 Processor: Intel or AMD
 Memory (RAM): min. 2GB
 Interfaces: USB*, maybe RS 232
 Network: TCP/IP

Client:

Operating system: Microsoft Windows 7, Microsoft Windows 8, Windows 10
 Processor: Intel or AMD
 Memory : min. 2GB
 Network: TCP/IP

* Required for USB-Dongle

The INOView system credits upgrade is available to monitor additional INOTEC emergency lighting systems. It's possible to purchase single system credits.

INOView licensing

The INOView software has to be licensed according to the amount of monitored INOTEC emergency lighting systems. The amount of needed system credits depends on the different device types.

Device type	System credits per device
CPS 220/64, CPUS 220/64, CPS 220/48.1, CPUS 220/48.1, CPS 220/48, CPUS 220/48 CPS 220/20 CPS FUSION DER 220	3
CLS 24/CLS 24.1, CLS 24-7Ah, CLS FUSION	1
NEA, LPS 24, BNS-MTB, NEA-ICU, ELS	2

INOView – Essential software package

Art. No. 185 405



INOView software - basic version with soft dongle

Art. No. 185 412



INOView – system credits upgrade

Art. No. 185 406

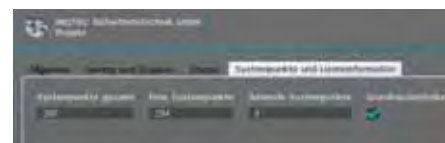

INOView floor plan upgrade

Art. No. 185 413



Standard network interface to INOTEC RTG-BUS for connection of INOTEC emergency lighting systems. RJ45 interface for connection to existing ethernet. Suitable for DIN-rail mounting.

Technical data

Material:	Polycarbonate
Nominal voltage:	24V ±10%
Power consumption:	1,7 VA
Terminals:	2,5mm ² single-core 1,5mm ² multi-core with ferrule
Perm. temperature range:	-15°C...+40°C
Protection category:	IP20
Protection class:	III
Acc. to DIN EN 55015	
Mounting:	DIN rail mounting

RTG interface for connection of up to 32 INOTEC emergency lighting systems to a PC via USB- or serial RS232- interface. Included in delivery:

- 1x Power supply
- 1x Connection cable 1m
- 1x Driver-CD for RTG – Interface (USB)

Technical data

Material:	Polycarbonate
Nominal voltage:	230V ±10%, 50/60Hz
Terminals:	2,5mm ²
Perm. temperature range:	-15°C...+40°C
Protection category:	IP20
Protection class:	II/III
Acc. to DIN EN 55015	

INOLan.2

Art. No. 990 253

Data interface

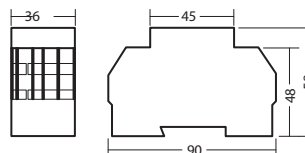

RTG - Interface (USB)

Art. No. 851 045

Data interface

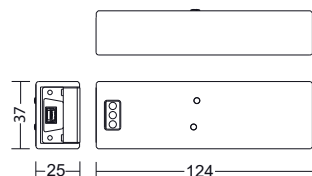

RTG - Interface (RS 232)

Art. No. 851 044

Data interface

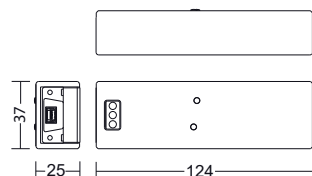

Dongle Device Server for integration into a virtual network environment. This component is needed, if the INOView server is installed on a virtual machine. The integration is done by network connection and a software within the virtual machine.

System requirements

Operating systems: 32/64-Bit: Windows XP, Windows 7, Windows 10, Windows Server 2008, Windows Server 2012

Network interfaces: 10BaseT/100BaseTX/1000BaseT

Interfaces: 2xUSB 2.0

INOView ZLT-Interface to communicate fault reports to the existing BMS. Suitable to connect to a remote switch as well as to loop monitoring. Five potential free contacts programmable for operation, failure (general) and 2 freely. Installed in distribution board, incl. power supply (146030)

Technical data

Material: Polycarbonate

Nominal voltage: 230 V ± 10%, 50/60 Hz

Terminals: 2,5 mm²

Perm. temperature range: -15 °C ... +40 °C

Protection category: IP30

Protection class: III

Acc. to to DIN EN 55015

The IB-Interface is a communication interface between INOView(180405) and ZLT-Interface(990227).
Included in delivery:
1x Power supply
1x Connection cable 1m
1x Driver - CD

Technical data

Material: Polycarbonate

Nominal voltage: 230 V ±10%, 50/60Hz

Terminals: 2,5 mm²

Perm. temperature range: -15 °C ... +40 °C

Protection category: IP20

Protection class: II/III

Acc. to DIN EN 55015

Dongle Device Server

optional accessory

Art. No. 185 050



INOView ZLT-Interface

optional accessory

Art. No. 990 227



IB-Interface (USB)

optional accessory

Art. No. 851 049

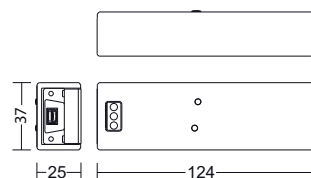

Regulations and Standards

What you need to know about emergency luminaires and exit signs

The following pages list the regulations and standards that apply to safety and emergency exit luminaires. These can be divided into lighting and electrical standards.



Lighting standards

EN 1838	Lighting applications. Emergency lighting
DIN 4844-1 / ISO3864	Graphical symbols - Safety colours and safety signs
DIN 4844-2	Graphical symbols - Safety colours and safety signs
DIN 4844-3	Graphical symbols - Safety colours and safety signs
ASR A1.3	Health and safety signs
ISO 7010	Graphical symbols – Safety colours and safety signs

Electrical standards

EN 60598-1	Luminaires – Part 1: General requirements and tests (10/15)
EN 60598-2-22	Luminaires – Part 2-22: Particular requirements – Luminaires for emergency lighting
EN 55015	Limits and methods of measurement of radio disturbance characteristics of electrical lighting and similar equipment

Lighting requirements for escape-routes according to EN 1838 10/2013

When the emergency lighting is in operation, the luminance of the safety colour must be at least 2 cd/m^2 at every point of the sign.

The colours must meet the requirements of ISO 3864.

A lamp's colour-rendering index, R_a , must be equal to at least 40.

The ratio of the luminance L_{contrast} to the luminance L_{safety} colour must be no less than 5:1 and no more than 15:1.

The ratio of the maximum luminance to the minimum luminance must not exceed 10:1 either within the white surface or within the safety colour.

Safety and exit sign luminaires have to be illuminated or by an internal or external illuminant. Fluorescent signs aren't allowed.

The light requirements of the standard are minimum values that also have to be achieved at the end of life of every component.

The planning of emergency light must be based on the worst environmental conditions for the entire expected lifetime (e.g. highest glare, minimum luminous flux (self-contained luminaires, light output reduced ballasts)).

For direct illuminating luminaires only the direct light has to be considered. Reflected light of surrounding walls must be neglected.

For indirect illuminating luminaires and ceiling floodlight, always working with a reflecting surface, only the first reflection must be considered.

If possible safety signs shouldn't be mounted higher than 20° above the horizontal viewing line with respect to the maximum viewing distance.

Example: Viewing person 2m tall

EW 20m $\rightarrow h_{\text{max}} = 9.2\text{m}$

EW 35m $\rightarrow h_{\text{max}} = 14.7\text{m}$

**Viewing distance according to EN 1838
10/2013 and DIN 4844-1 06/2012**

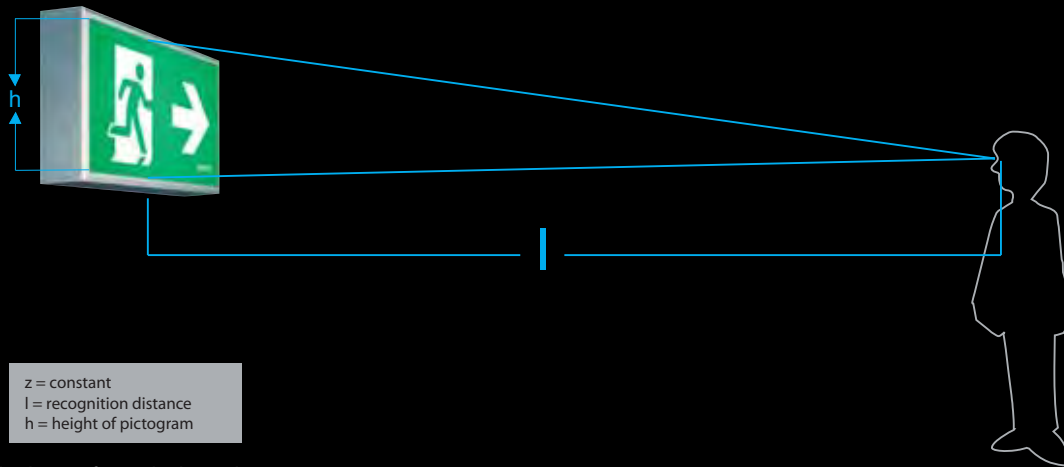

Calculation formula: $l = z \cdot h$
 $z = 100$ - for illuminated signs, but only when the illuminance on the surface of the sign is $E \geq 50 \text{ lx}$.
 $z = 200$ - for backlit signs (pictogram luminaires), but only when the luminance is $L \geq 500 \text{ cd/m}^2$ in mains operation.

Rule of thumb:
 Pictogram signs need to be twice as large as pictogram luminaires at the same recognition distance.

Note:
 With the luminance $L=500 \text{ cd/m}^2$ given above, the pictogram should be sufficiently recognisable in bright surroundings. In order to avoid glare effects, the luminance needs to be reduced in dark surroundings, for instance by the use of INOTEC pictogram luminaires with adjustable light output in monitored LED technology.



Emergency signs according to ISO 7010

Examples



The arrows may only be used in conjunction with an additional exit pictogram and vice-versa.
 The arrows may be rotated in 45° increments.
 In combination signs, the light edges between the pictograms may be omitted.

Emergency lighting for escape routes

For escape routes with a width of up to 2m, the horizontal illuminance on the floor along the central line of the escape route must be no less than 1lx, and the central area, corresponding to no less than half the width of the escape route, must be illuminated with at least 50% of this value.

The ratio of the maximum illuminance to the minimum illuminance must not exceed 40:1 along the central line of the escape route.

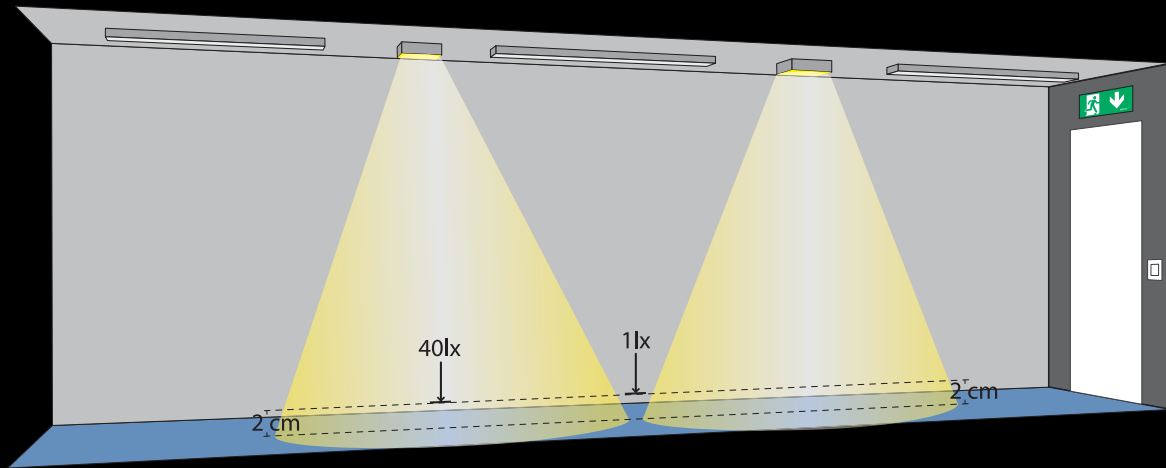

Type of lighting	Required illuminance	Uniformity (E_{min}/E_{max})
Safety lighting for escape routes:	1 lux (*2) along the central line of the emergency route	1:40
Safety lighting for hazardous areas:	10% of general lighting, minimum 15 lux (*2)	1:10
Open space lighting:	Minimum 0.5 lux (*2) on the free floor surface	1:40

Type of lighting	Rated operating time	Response time (*1)
Safety lighting for escape routes:	At least 1 hour	50% of E_{min} within 5 seconds, 100% within 60s (for German workplaces, 100% within 15s)
Safety lighting for hazardous areas:	The rated operating time must correspond to the length of time for which danger exists for humans	The required illuminance must be permanently present or achieved within 0.5 seconds
Anti-panic lighting:	At least 1 hour	50% of E_{min} within 5 seconds, 100% within 60 seconds

(*1) Interval between failure of the general lighting and achievement of required illumination level by the emergency lighting

(*2) Measurement plane $\leq 2\text{cm}$ above the floor.

Physiological glare

Physiological glare must be kept low by limiting the luminosity of the luminaires within the field of vision.

For escape routes that run horizontally, the luminosity within an area of 60° to 90° to the vertical must not exceed the values in the table for all azimuth angles. For all other escape routes and open areas, the limits must not be exceeded for any angle.

Limits for physiological glare

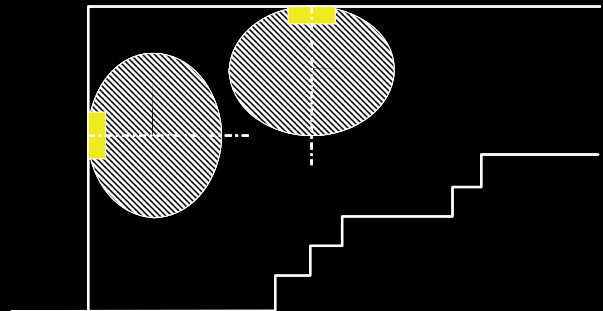
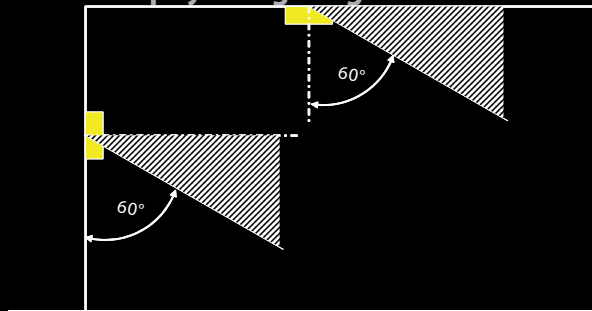

Mounting height above the ground h	Maximum luminosity for escape route and open area emergency lighting I_{max}	Maximum luminosity for safety lighting for hazardous areas I_{max}
m	cd	cd
$h < 2.5$	500	1000
$2.5 \leq h < 3.0$	900	1800
$3.0 \leq h < 3.5$	1600	3200
$3.5 \leq h < 4.0$	2500	5000
$4.0 \leq h < 4.5$	3500	7000
$h \geq 4.5$	5000	10000

Spots to be highlighted according to EN 1838



at least 2m above the ground

at each exit door which can be used in emergency



close to (*1) each first-aid station (*2)

close to (*1) any firefighting or alarm device

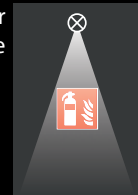

Safety signs and directional emergency escape route signs have to be illuminated or backlit in emergency mode. Photoluminescent signs are not allowed.



close to (*1) evacuation devices for handicapped people

close to (*1) stairs, in order to illuminate each step directly



close to (*1) safe areas for handicapped people and intercoms for these as well as alarm devices for disabled toilets



close to (*1) any level change within the escape route



anti-panic lighting in disabled toilets

at each change of direction



anti-panic lighting on paths to areas where safety lighting is required, but not directly adjacent to an escape route

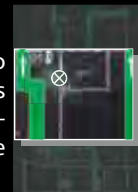

at each intersection of corridors / passages



outside and close to (*1) every emergency exit door up to a safe area

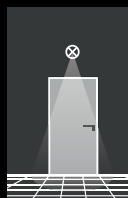

*1 max. 2m horizontal distance
*2 vertical illuminance 5lx

Electrical standards

The electrical standards are taken into account in INOTEC's own construction and development and monitored by our quality control. We guarantee that all INOTEC luminaires comply with the current standards and regulations. You can find the corresponding declarations of conformity on our homepage.

Special colours

The choice is yours ...

If an INOTEC luminaire needs to be colour-matched to customer requirements, INOTEC offers two options: the standard powder coating or the INOTEC high-performance powder coating system.

All luminaires which are used indoors without special stress (IP 4x) can be painted with the standard powder coating. By selecting the appropriate RAL colour, the luminaires can be customised to suit the architecture and colour scheme of the building.

If luminaires with a high degree of protection are required, the INOTEC high-performance powder coating system is used. This coating is a 2-layer powder coating with excellent corrosion protection. INOTEC luminaires with the high-performance powder coating system are ideal for use in rough environments - in- and outdoor. These luminaires can be used in industrial plants, swimming pools or facades without any problems.

Even under strong weather conditions, such as sunlight, temperature and humidity, there is no change in the surface or optical reduction for years. Even aggressive liquids do not damage the high-performance powder coating. By pre-treating the surfaces accordingly, even scratches in the powder coating cannot be infiltrated by rust.



Environmentally friendly and economical

Coatings without solvent emission? Powder coatings make it possible! Powder coatings do not produce any solvent emissions compared to wet coating processes. Therefore the INOTEC powder coatings comply with the EU directives* regarding VOC**. In addition, there are numerous other environmentally relevant advantages of powder coating systems: No waste water is generated during processing, and due to a very high application efficiency (up to 98 %), the amount of waste generated during powder coating processing is very low.

* Ratified in Germany under 31. BImSchV

** The abbreviation VOC (Volatile Organic Compounds) refers to the group of volatile organic compounds (e.g. solvents).

Lighting technology

Measures and units of light

Luminous flux Φ (lumen)

The luminous flux measures the total light output emitted in a spherical radius by the illuminant. It is adjusted to reflect the varying sensitivity of the human eye to different light wavelengths.

The luminous flux is indicated in lumen (lm).

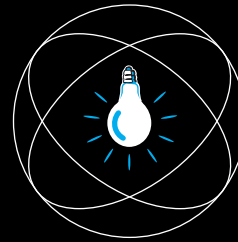

Illuminance E (lux)

Illuminance is a deciding factor in our visual performance. Illuminance therefore has a major influence on how quickly and safely people can leave a building in an emergency.

Illuminance indicates the relationship of the luminous flux falling perpendicularly on a surface to the illuminated surface. Under EN 1838, the minimum illuminance is 1 lux, measured on the central line of the escape route. The maintenance factor must also be taken into consideration. For our spacing tables, we base our calculations on a maintenance factor of 0.8, producing a minimum illuminance of 1.25 lux.

Illuminance is measured with a lux meter at a height of 2cm above the ground.

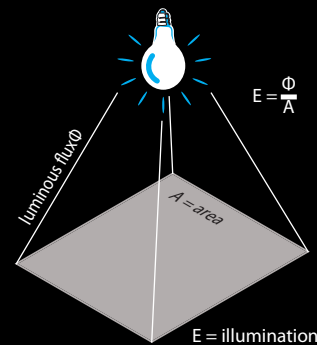

Luminance L (candela / m²)

Luminance is the luminous intensity of a surface. The surface can produce the light itself, or be backlit or illuminated.

In accordance with DIN prEN 1838, the luminance of the safety colour must be at least 2 cd/m² at every point of the sign, from every relevant viewing direction.

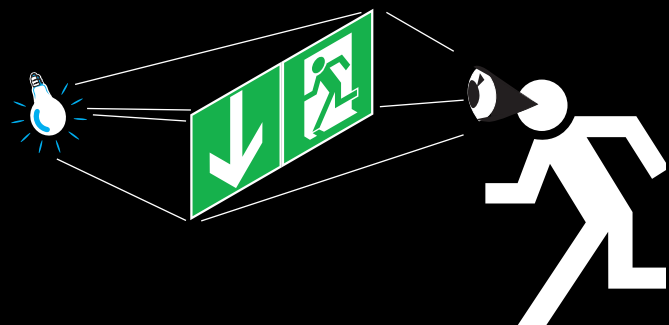

Some facts about LEDs

IINOTEC has many years of experience working with LEDs. Thanks to ongoing developments, LEDs offer countless new possibilities in luminaire design.

How a LED works

LED is the abbreviation of **L**ight **E**mitting **D**iode. A LED is a semiconductor diode that emits light when operated in the conducting direction (anode [+] -> cathode [-]). The light's wavelength essentially depends on the semiconductor material used and on its doping. Nowadays, LEDs can reach a luminous flux of more than 120lm/watt. These figures are manufacturer's specifications, measured under laboratory conditions (25°C chip temperature and a current of 350mA).

Service life

The LEDs used by INOTEC have an average service life of approx. 50,000h. To achieve this service life, good thermal management is required, as a LED's service life essentially depends on the temperature and the current flowing through it.

LEDs and PCBs

INOTEC emergency exit and safety luminaires use PCBs (printed circuit boards) that have been specially developed for luminaires, fitted with SMD (surface mount) LEDs. This means that the LED can be perfectly matched to the luminaire design. Secondary optics are used to optimise the light distribution of the LED illuminant for the various areas of application.

LED power supplies

The LEDs are operated with INOTEC constant current power supplies. PSUs with different performance classes were developed for the various application areas, suitable for connection to central and low power supply systems under DIN VDE 0108 and EN 50171. Depending on the version, the LED PSUs also come with integrated Joker technology and individual lamp monitoring. Furthermore, the luminaires can be dimmed in mains operation and automatically switch to 100% in emergency operation.



Contents



SN 2040.1



FS 804.1



FL 3100



FS 1100



SNP 1530.1

SNP 1520.1

Straight-Line

Meeting the highest demands



SNP 1023.1

SNP 1018.2

SNP 1016.2

SNP 1118

SNP 1116

Edge lights

Highlighting modern internal architecture



SNP 7168.1 UP

SNP 7183/7283

SNP 7188/7288

SNP 7186/7286

SNP 7184/7284

Aluminium luminaires

The all-rounder



SNP 2435

SNP 2420

Four-sided exit luminaires

with a pictogram ratio of 2:1



SN 6307

SN(P) 2004

SN 6204.2

SN 6114

SN 6110

Wall and step luminaires

Safety and orientation luminaires

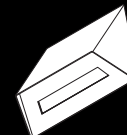

SN 804.1

SN 804.1 WT

SNP 828

SNP 808

SNP 818

Stainless steel luminaires

Robust luminaires with a high protection rating

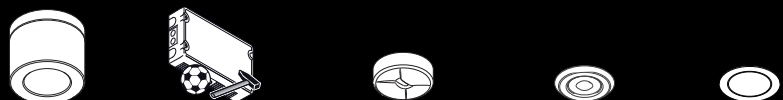

SN 8040

SN 8500

SN 8400

SN 9400

SN 9100 TES

Downlights

Powerful and variable



SN 8030

SNP8030

Ball- and impact resistant luminaires

Ideal for use in sports facilities



SNP 1006

SN 2100

SNP 2230

SNP 2130

Moulded plastic luminaires

Universal emergency exit and safety luminaires



FL 828

FL 808

FL 7288

FL 7188

FL 1530

Segmental luminaires

Versatile D.E.R. luminaires



EX 7102

EX luminaires

Explosion-proof emergency exit and safety luminaires





Straight-Line

Meeting the highest demands



Besides the high quality and ease of installation, the INOTEC emergency exit sign luminaires of the "Straight-Line" series suit perfectly to modern architectures. The luminaires impress with their slim design and homogeneous illumination. Thanks to their high luminance > 500cd/m², these luminaires are ideally suited for use in bright environments and thus meet the requirements of DIN 4844-1.

Advantages

- State-of-the-art lighting technology
- High quality materials
- Attractive design
- Easy installation
- Easily exchangeable legend panel

Applications

- Public buildings with elegant room architecture
- Offices
- Commercial properties
- Theater
- Shop premises
- VIP-areas
- Hotels
- etc.

	SNP 1520.1	85
	SNP 1530.1	91





Straight-Line high quality emergency exit luminaires, made of powder coated aluminium profile of just 14.5mm thickness. Slim design and brilliant illumination by cutting-edge fibre optics technology with a luminance of $>500\text{cd/m}^2$.

Technical data

Viewing distance:	20 m	Apparent power:	4,1 VA
Material:	Aluminium powder-coated	Effective power:	3,5 W
Illuminant:	LEDs	Inrush current:	8 A / 50 μs
Nominal voltage AC:	230V $\pm 10\%$ 50/60 Hz	Protection class:	I
Nominal voltage DC:	176 - 264 V	Input terminals:	2.5mm ² feed through wiring
Nominal current AC:	18 mA	Temperature ta:	-15...+40 °C
Nominal current DC:	14 mA		

Available colours Add colour code to the article no. e.g. 800 014 LXX

RAL 7015 (Slate grey): **L16** ■ RAL 9016 (Traffic white): **L04** □ Special colour: **L99** 🌈

Articles

SNP 1520.1 D / WA LED J/SV

Art. no. 801 403

Wall bracket or ceiling mounting

Protection category: IP40

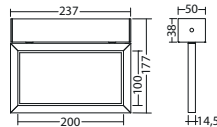

SNP 1520.1 E LED J/SV

Art. no. 801 414

Recessed ceiling mounting

Protection category: IP40

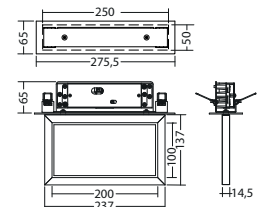

SNP 1520.1 ES LED J/SV

Art. no. 801 417

Recessed cable suspension

Protection category: IP40

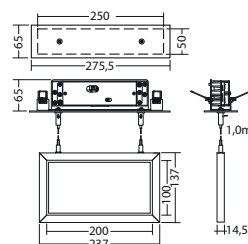

SNP 1520.1 P LED J/SV

Art. no. 801 409

Pendulum mounting

Protection category: IP40

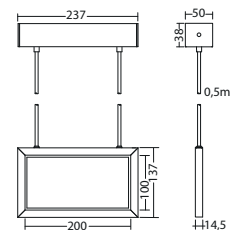

SNP 1520.1 PM LED J/SV

Art. no. 801 400

Parallel wall mounting

Protection category: IP40

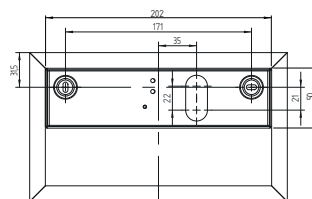

SNP 1520.1 S LED J/SV

Art. no. 801 406

Cable suspension mounting

Protection category: IP40

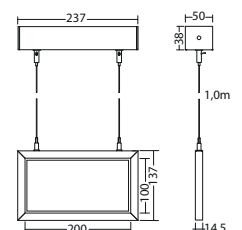

Quality and efficiency

High quality materials

The INOTEC Straight-Line, made of high-quality aluminium profiles, impresses with a flat design and homogeneous illumination.

Due to their high luminance $> 500\text{cd/m}^2$, these luminaires are ideally suited for use in bright environments and thus meet the requirements of the standard.

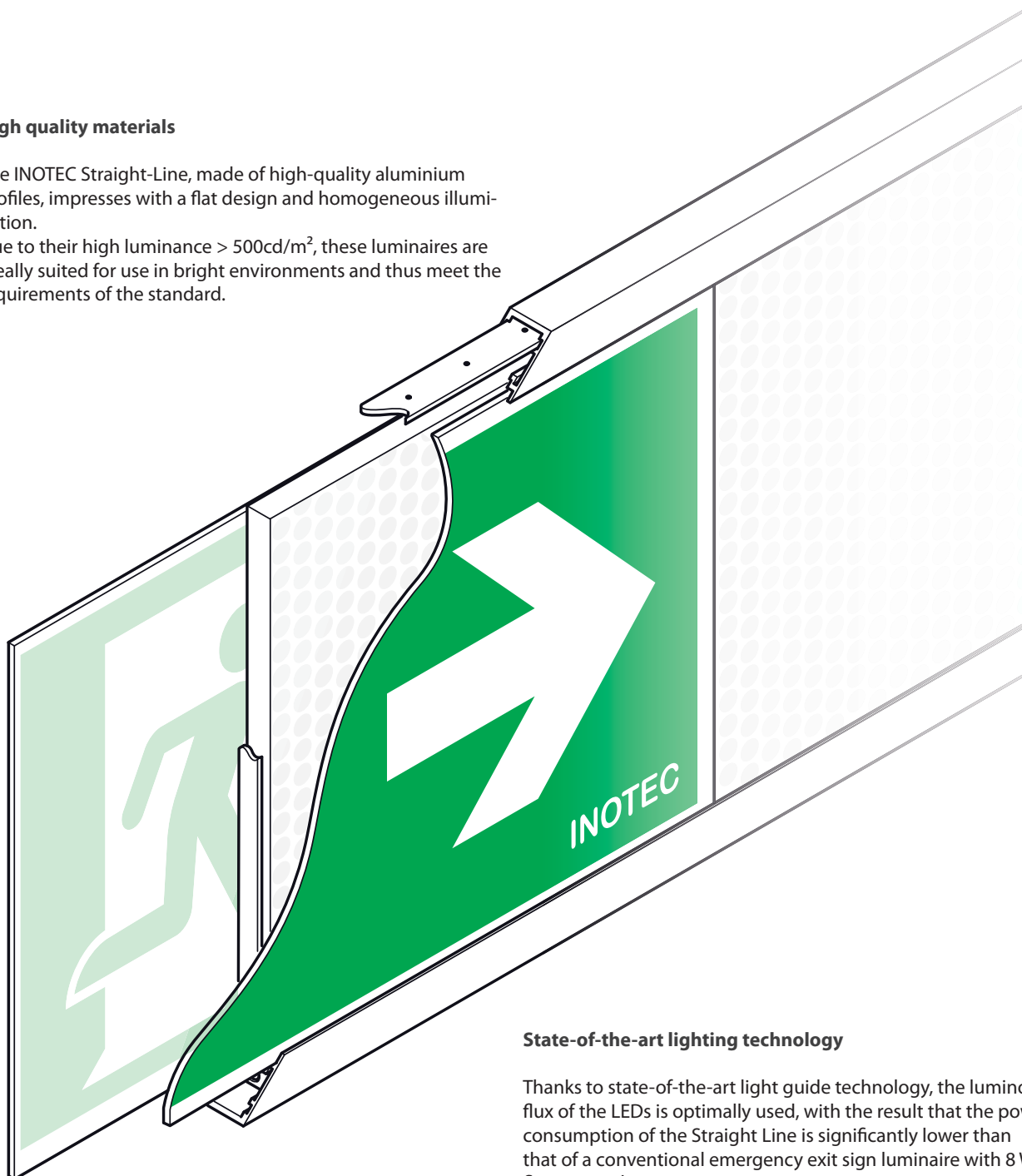

State-of-the-art lighting technology

Thanks to state-of-the-art light guide technology, the luminous flux of the LEDs is optimally used, with the result that the power consumption of the Straight Line is significantly lower than that of a conventional emergency exit sign luminaire with 8 W fluorescent lamp.

A screened light guide panel inside the luminaire ensures uniform and bright illumination of the pictogram panels.

This system also makes it possible to change the pictogram screens easily and without tools.

SNP 1520.1 WE LED J/SV

Art. no. 801 412

Recessed wall mounting

Protection category: IP40

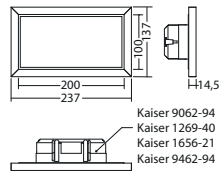

LED-Supply 230-3 J-SV SK I UP

Art. no. 890 435

required





3

4



6





Straight-Line high quality emergency exit luminaires, made of powder coated aluminium profile of just 14.5mm thickness. Slim design and brilliant illumination by cutting-edge fibre optics technology with a luminance of >500cd/m².

Technical data

Viewing distance:	30 m	Apparent power:	5,2 VA
Material:	Aluminium powder-coated	Effective power:	4,3 W
Illuminant:	LEDs	Inrush current:	8 A / 50 µs
Nominal voltage AC:	230V ±10% 50/60 Hz	Protection class:	I
Nominal voltage DC:	176 - 264 V	Input terminals:	2.5mm ² feed through wiring
Nominal current AC:	23 mA	Temperature ta:	-15...+40 °C
Nominal current DC:	18 mA		

Available colours Add colour code to the article no. e.g. 800 014 LXX

RAL 7015 (Slate grey): **L16** ■ RAL 9016 (Traffic white): **L04** □ Special colour: **L99** 🌈

Articles

SNP 1530.1 D / WA LED J/SV

Art. no. 801 423

Wall bracket or ceiling mounting

Protection category: IP40

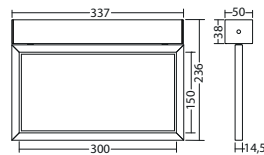

SNP 1530.1 E LED J/SV

Art. no. 801 434

Recessed ceiling mounting

Protection category: IP40

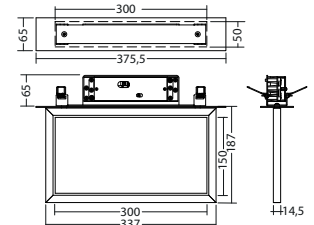

SNP 1530.1 ES LED J/SV

Art. no. 801 437

Recessed cable suspension

Protection category: IP40

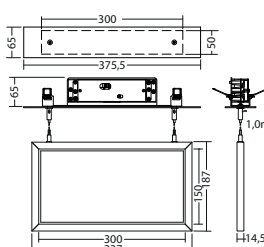

SNP 1530.1 P LED J/SV

Art. no. 801 429

Pendulum mounting

Protection category: IP40

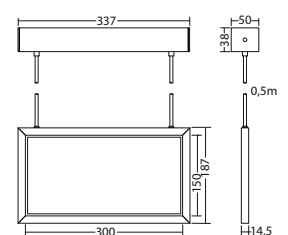

SNP 1530.1 PM LED J/SV

Art. no. 801 420

Parallel wall mounting

Protection category: IP40

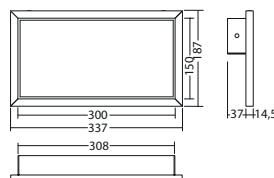

SNP 1530.1 S LED J/SV

Art. no. 801 426

Cable suspension mounting

Protection category: IP40

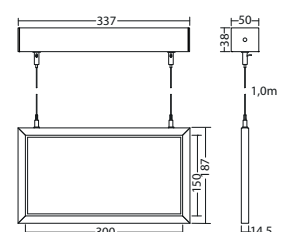

Versatile and ergonomic

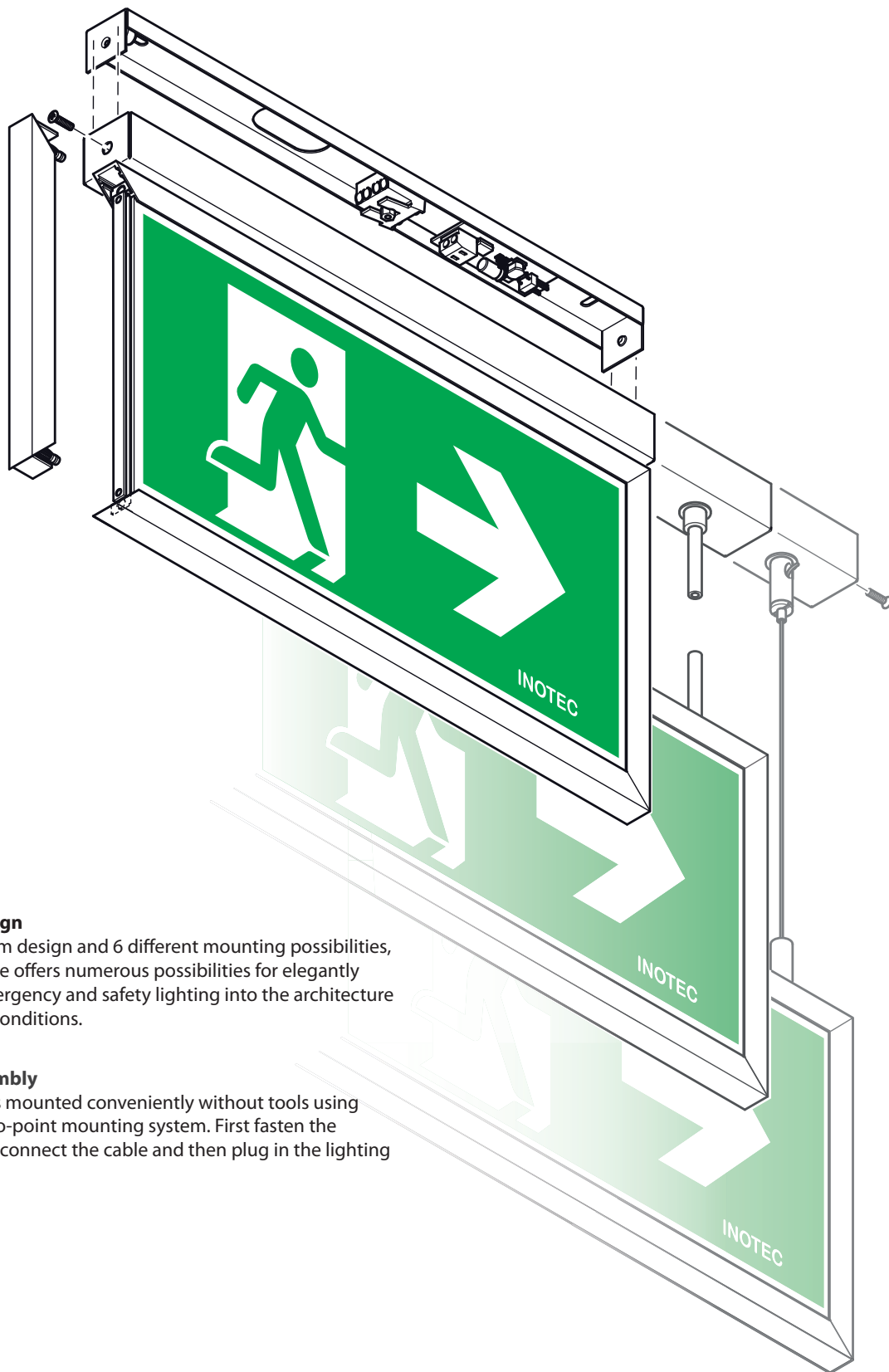
**Attractive design**

Thanks to its slim design and 6 different mounting possibilities, the Straight-Line offers numerous possibilities for elegantly integrating emergency and safety lighting into the architecture and structural conditions.

Tool-free assembly

The luminaire is mounted conveniently without tools using a pluggable two-point mounting system. First fasten the mounting unit, connect the cable and then plug in the lighting module.

SNP 1530.1 WE LED J/SV

Art. no. 801 432

Recessed wall mounting

Protection category: IP40

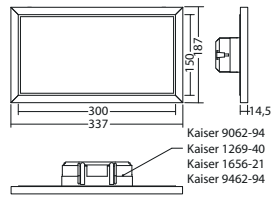

LED-Supply 230-3 J-SV SK I UP

Art. no. 890 435

required







Edge lights

The highlight of modern room architecture

The INOTEC edge lights with freely suspended pictogram screens offer more than perfect safety technology, they set clear accents.





With trend-setting technologies and premium materials in elegant design, the luminaires set standards in functionality, flexibility and standard-compliant illumination.

Advantages

- Attractive design
- Easily exchangeable legend panel
- Tool-free opening

Applications

- Public buildings with elegant room architecture
- Offices
- Shop premises
- Conference facilities
- VIP-areas
- Hotels
- etc.

	SNP 1116	98
	SNP 1118	100
	SNP 1016	104
	SNP 1018	106
	SNP 1023	109



Set accents

The INOTEC edge light luminaires SNP 1116 and SNP 1118 convince in function, luminous intensity, service life and design. The high-quality stainless steel luminaires are highly flexible with the adjustable pictogram and are therefore suitable for almost any mounting situation. Thus, the optimum solution for every wall and room situation can also be found retrospectively.

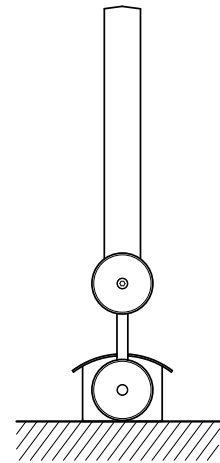

Upside down - seen it already??

**With the Akzent luminaire,
(almost) anything is possible**

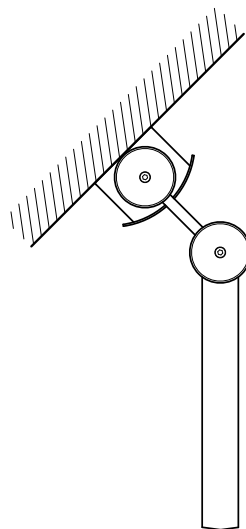
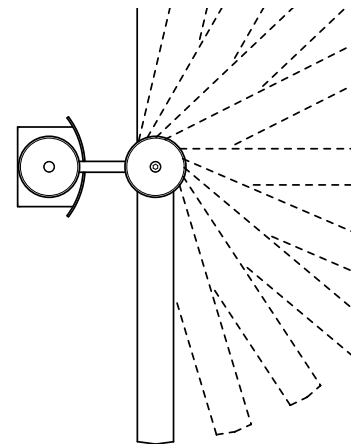
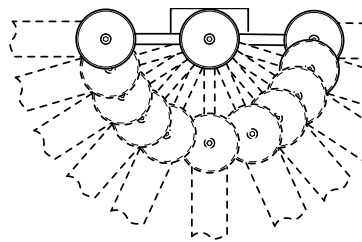

Sloping walls - already had?

Vertical mounting - already planned?

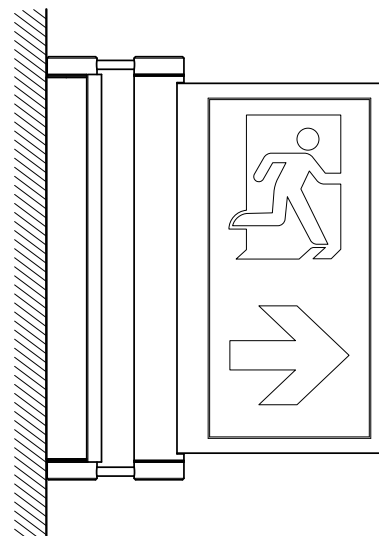



High quality, versatile LED edge lights made of brushed stainless steel. Homogeneous illumination of the frameless, free hanging 20 mm acrylic legend panel by state-of-the-art LED technology.

Technical data

Viewing distance:	22 m	Nominal current DC:	17 mA
Material:	Stainless steel brushed	Apparent power:	4,5 VA
Illuminant:	LEDs	Inrush current:	8 A / 50 μ s
Nominal voltage AC:	230V \pm 10% 50/60 Hz	Protection class:	I
Nominal voltage DC:	176 - 264 V	Input terminals:	2.5mm ² feed through wiring
Nominal current AC:	20 mA	Temperature ta:	-15...+40 °C

Articles

SNP 1116 D LED J/SV

Art. no. 801 185

Wall or ceiling mounting

Protection category: IP20

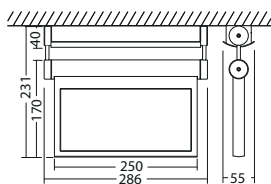

SNP 1116 P LED J/SV

Art. no. 801 485

Pendulum mounting

Protection category: IP20

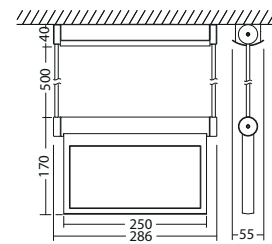

SNP 1116 S LED J/SV

Art. no. 801 585

Cable suspension mounting

Protection category: IP20

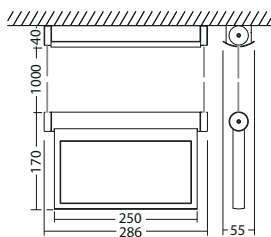



High quality, versatile LED edge lights made of brushed stainless steel. Homogeneous illumination of the frameless, free hanging 20 mm acrylic legend panel by state-of-the-art LED technology.

Technical data

Viewing distance:	22 m	Nominal current DC:	17 mA
Material:	Stainless steel brushed	Apparent power:	4,5 VA
Illuminant:	LEDs	Inrush current:	8 A / 50 μ s
Nominal voltage AC:	230V \pm 10% 50/60 Hz	Protection class:	I
Nominal voltage DC:	176 - 264 V	Input terminals:	2.5mm ² feed through wiring
Nominal current AC:	20 mA	Temperature ta:	-15...+40 °C

Available colours Add colour code to the article no. e.g. 800 014 LXX

stainless steel: **L30** ■ Special colour: **L99** ■

Articles

SNP 1116.2 E LED J/SV

Art. no. 801 063 .2

Recessed ceiling mounting

Protection category: IP20

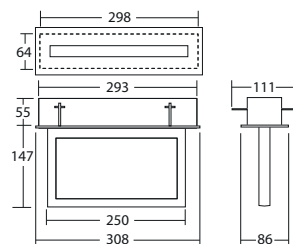

recessed box for concrete ceiling inst.

Art. no. 890 698

optional accessories

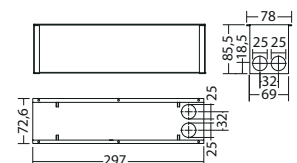



High quality, versatile LED edge lights made of brushed stainless steel. Homogeneous illumination of the frameless, free hanging 20 mm acrylic legend panel by state-of-the-art LED technology.

Technical data

Viewing distance:	30 m	Nominal current DC:	22 mA
Material:	Stainless steel brushed	Apparent power:	5,3 VA
Illuminant:	LEDs	Inrush current:	8 A / 50 µs
Nominal voltage AC:	230V ±10% 50/60 Hz	Protection class:	I
Nominal voltage DC:	176 - 264 V	Input terminals:	2.5mm ² feed through wiring
Nominal current AC:	23 mA	Temperature ta:	-15...+40 °C

Articles

SNP 1118 D LED J/SV

Art. no. 801 195

Wall or ceiling mounting

Protection category: IP20

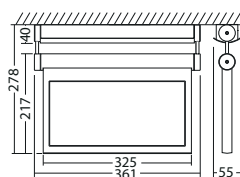

SNP 1118 P LED J/SV

Art. no. 801 495

Pendulum mounting

Protection category: IP20

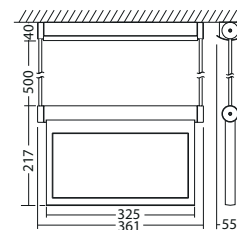

SNP 1118 S LED J/SV

Art. no. 801 595

Cable suspension mounting

Protection category: IP20

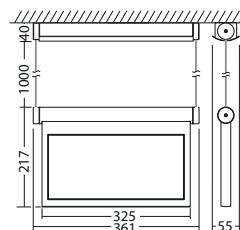



High quality, versatile LED edge lights made of brushed stainless steel. Homogeneous illumination of the frameless, free hanging 20 mm acrylic legend panel by state-of-the-art LED technology.

Technical data

Viewing distance:	30 m	Nominal current DC:	22 mA
Material:	Stainless steel brushed	Apparent power:	5,3 VA
Illuminant:	LEDs	Inrush current:	8 A / 50 μ s
Nominal voltage AC:	230V \pm 10% 50/60 Hz	Protection class:	I
Nominal voltage DC:	176 - 264 V	Input terminals:	2.5mm ² feed through wiring
Nominal current AC:	23 mA	Temperature ta:	-15...+40 °C

Available colours Add colour code to the article no. e.g. 800 014 LXX

stainless steel: **L30** ■ Special colour: **L99** ■

Articles

SNP 1118.2 E LED J/SV

Art. no. 801 083 .2

Recessed ceiling mounting

Protection category: IP20

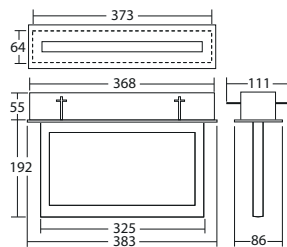

recessed box for concrete ceiling inst.

Art. no. 890 699

optional accessories

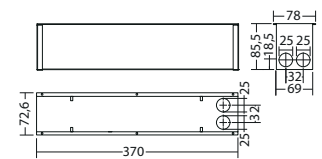



The installation-friendly eye-catcher

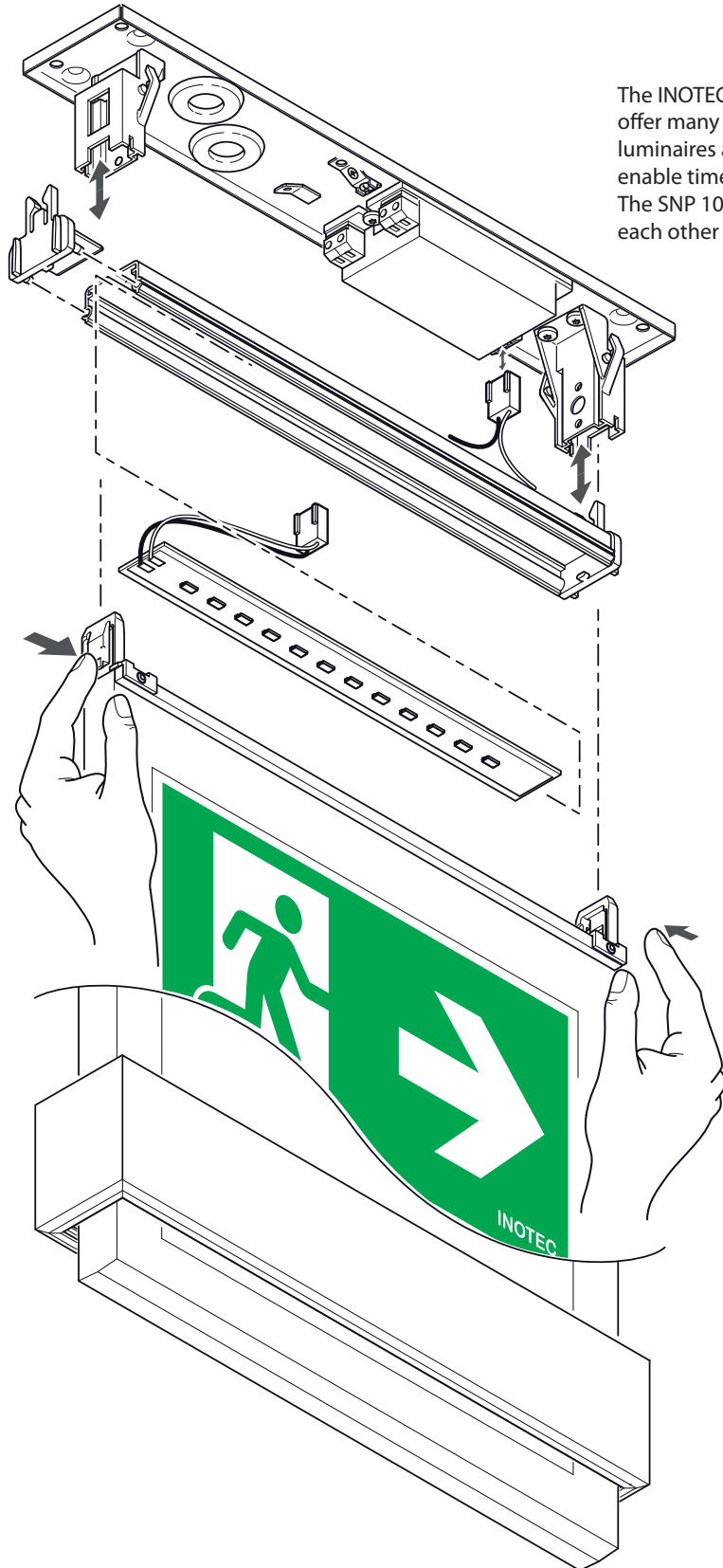

The INOTEC edge light luminaires SNP 1016 and SNP 1018 offer many advantages with their screwless connections. The luminaires are made from high-quality aluminium profiles and enable time- and cost-saving installation and maintenance. The SNP 1016 and SNP 1018 edge light luminaires complement each other perfectly in terms of functionality and comfort.



Functional edge lights made of high quality aluminium profile. Homogeneous illumination of the frameless, free hanging 20 mm acrylic pictogram oder legend panel by state-of-the-art LED technology.

Technical data

Viewing distance:	22 m	Nominal current DC:	17 mA
Material:	Aluminium	Apparent power:	4,5 VA
Illuminant:	LEDs	Inrush current:	8 A / 50 µs
Nominal voltage AC:	230V ±10% 50/60 Hz	Protection class:	I
Nominal voltage DC:	176 - 264 V	Input terminals:	2.5mm ² feed through wiring
Nominal current AC:	20 mA	Temperature ta:	-15...+40 °C

Articles

SNP 1016.2 D LED J/SV

Art. no. 801 163 .2

Ceiling mounting

Protection category: IP20

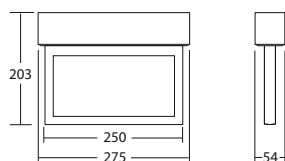

SNP 1016.2 P LED J/SV

Art. no. 801 463 .2

Pendulum mounting

Protection category: IP20

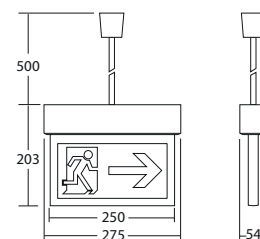

SNP 1016.2 PM LED J/SV

Art. no. 801 363 .2

Parallel wall mounting

Protection category: IP20

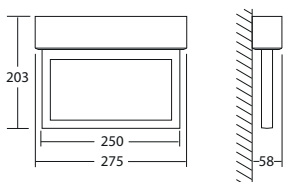

SNP 1016.2 S LED J/SV

Art. no. 801 464 .2

Cable suspension mounting

Protection category: IP20

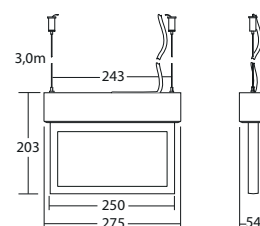

SNP 1016.2 WA LED J/SV

Art. no. 801 263 .2

Wall bracket mounting

Protection category: IP20





Functional edge lights made of high quality aluminium profile. Homogeneous illumination of the frameless, free hanging 20 mm acrylic pictogram oder legend panel by state-of-the-art LED technology.

Technical data

Viewing distance:	22 m	Nominal current DC:	17 mA
Material:	Aluminium	Apparent power:	4,5 VA
Illuminant:	LEDs	Inrush current:	8 A / 50 μ s
Nominal voltage AC:	230V \pm 10% 50/60 Hz	Protection class:	I
Nominal voltage DC:	176 - 264 V	Input terminals:	2.5mm ² feed through wiring
Nominal current AC:	20 mA	Temperature ta:	-15...+40 °C

Available colours Add colour code to the article no. e.g. 800 014 LXX

RAL 9016 (Traffic white): **L04** Special colour: **L99**

Articles

SNP 1016.2 E LED J/SV

Art. no. 801 064 .2

Recessed ceiling mounting

Protection category: IP20

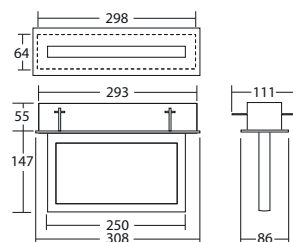

recessed box for concrete ceiling inst.

Art. no. 890 698

optional accessories

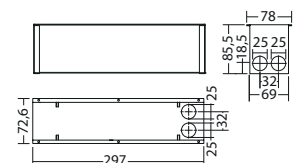



Functional edge lights made of high quality aluminium profile. Homogeneous illumination of the frameless, free hanging acrylic pictograph by state-of-the-art LED technology.

Technical data

Viewing distance:	30 m	Nominal current DC:	22 mA
Material:	Aluminium	Apparent power:	5,3 VA
Illuminant:	LEDs	Inrush current:	8 A / 50 µs
Nominal voltage AC:	230V ±10% 50/60 Hz	Protection class:	I
Nominal voltage DC:	176 - 264 V	Input terminals:	2.5mm ² feed through wiring
Nominal current AC:	23 mA	Temperature ta:	-15...+40 °C

Articles

SNP 1018.2 D LED J/SV

Art. no. 801 169.2

Ceiling mounting

Protection category: IP20

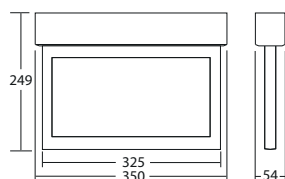

SNP 1018.2 P LED J/SV

Art. no. 801 469.2

Pendulum mounting

Protection category: IP20

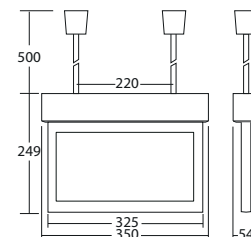

SNP 1018.2 PM LED J/SV

Art. no. 801 369.2

Parallel wall mounting

Protection category: IP20

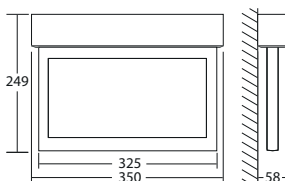

SNP 1018.2 S LED J/SV

Art. no. 801 468.2

Cable suspension mounting

Protection category: IP20

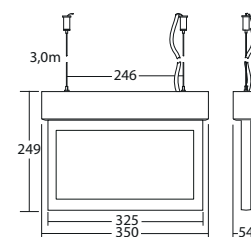

SNP 1018.2 WA LED J/SV

Art. no. 801 269.2

Wall bracket mounting

Protection category: IP20

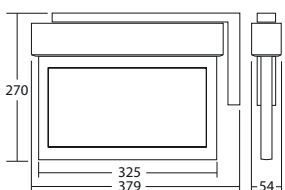



Functional edge lights made of high quality aluminium profile. Homogeneous illumination of the frameless, free hanging acrylic pictograph by state-of-the-art LED technology.

Technical data

Viewing distance:	30 m	Nominal current DC:	22 mA
Material:	Aluminium	Apparent power:	5,3 VA
Illuminant:	LEDs	Inrush current:	8 A / 50 μ s
Nominal voltage AC:	230V \pm 10% 50/60 Hz	Protection class:	I
Nominal voltage DC:	176 - 264 V	Input terminals:	2.5mm ² feed through wiring
Nominal current AC:	23 mA	Temperature ta:	-15...+40 °C

Available colours Add colour code to the article no. e.g. 800 014 LXX

RAL 9016 (Traffic white): **L04** Special colour: **L99**

Articles

SNP 1018.2 E LED J/SV

Art. no. 801 069 .2

Recessed ceiling mounting

Protection category: IP20

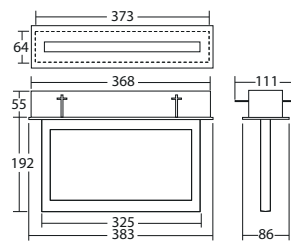

recessed box for concrete ceiling inst.

Art. no. 890 699

optional accessories

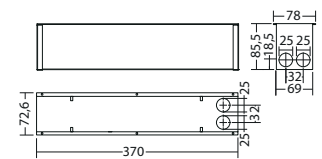





Functional edge lights made of high quality aluminium profile. Homogeneous illumination of the frameless, free hanging acrylic pictograph by state-of-the-art LED technology.

Technical data

Viewing distance:	50 m	Nominal current DC:	85 mA
Material:	Aluminium	Apparent power:	21,6 VA
Illuminant:	LEDs	Protection class:	I
Nominal voltage AC:	230V ±10% 50/60 Hz	Input terminals:	2.5mm ² feed through wiring
Nominal voltage DC:	176 - 264 V	Temperature ta:	-15...+40 °C
Nominal current AC:	94 mA		

Articles

SNP 1023.1 D LED J/SV Art. no. 801 760

Ceiling mounting

Protection category: IP20

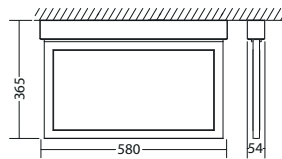

SNP 1023.1 E LED J/SV Art. no. 801 764

Recessed ceiling mounting

Protection category: IP20

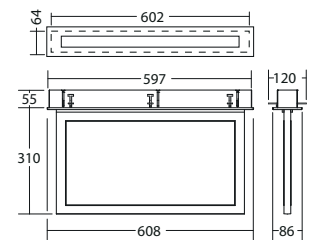

SNP 1023.1 P LED J/SV Art. no. 801 762

Pendulum mounting

Protection category: IP20

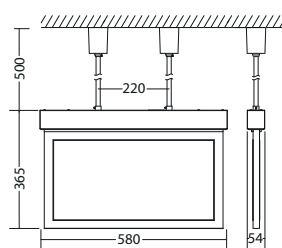

SNP 1023.1 PM LED J/SV Art. no. 801 766

Parallel wall mounting

Protection category: IP20

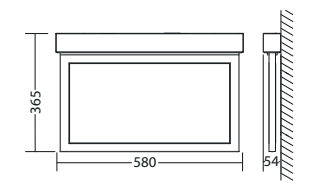



Aluminium luminaires

The all-rounders

The INOTEC aluminium profile luminaires are especially characterised by their versatile application possibilities. Due to the different housing sizes and the possibility of individual colour design, the aluminium profile luminaires can be well adapted to the interior architecture of the building.

Advantages

- Attractive design
- Easily exchangeable pictograms
- Tool-free opening

Applications

- Public buildings with elegant room architecture
- Offices
- Shop premises

	SNP 7184/7284	112
	SNP 7186/7286	116
	SNP 7188/7288	118
	SNP 7183/7283	120
	SNP 7168.1 UP	123



Single sided aluminium profile emergency exit luminaires with additional light output at bottom side. Homogeneous illumination by state-of-the-art LED technology with a luminance of $> 500 \text{ cd/m}^2$.

Technical data

Viewing distance:	12 m	Nominal current DC:	12 mA
Material:	Aluminium	Apparent power:	5,0 VA
Illuminant:	LEDs	Inrush current:	8 A / 50 μs
Nominal voltage AC:	230V $\pm 10\%$ 50/60 Hz	Protection class:	I
Nominal voltage DC:	176 - 264 V	Input terminals:	2.5mm ² feed through wiring
Nominal current AC:	22 mA	Temperature ta:	-15...+40 °C

Available colours Add colour code to the article no. e.g. 800 014 LXX

Special colour: L99 

Articles

SNP 7184 LED J/SV

Art. no. 807 534

Wall mounting

Protection category: IP40

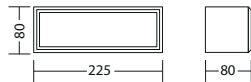



Double-sided aluminium profile emergency exit luminaires with additional light output at bottom side. Homogeneous illumination by state-of-the-art LED technology with a luminance of $> 500 \text{ cd/m}^2$.

Technical data

Viewing distance:	12 m	Nominal current DC:	18 mA
Material:	Aluminium	Apparent power:	6,1 VA
Illuminant:	LEDs	Inrush current:	8 A / 50 μs
Nominal voltage AC:	230V $\pm 10\%$ 50/60 Hz	Protection class:	I
Nominal voltage DC:	176 - 264 V	Input terminals:	2.5mm ² feed through wiring
Nominal current AC:	27 mA	Temperature ta:	-15...+40 °C

Available colours Add colour code to the article no. e.g. 800 014 LXX

Special colour: L99 

Articles

SNP 7284 D LED J/SV

Art. no. 807 544

Ceiling mounting

Protection category: IP40

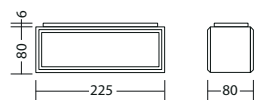







Single sided aluminium profile emergency exit luminaires with additional light output at bottom side. Homogeneous illumination by state-of-the-art LED technology with a luminance of $> 500 \text{ cd/m}^2$.

Technical data

Viewing distance:	20 m	Nominal current DC:	12 mA
Material:	Aluminium	Apparent power:	5,0 VA
Illuminant:	LEDs	Inrush current:	8 A / 50 μs
Nominal voltage AC:	230V $\pm 10\%$ 50/60 Hz	Protection class:	I
Nominal voltage DC:	176 - 264 V	Input terminals:	2.5mm ² feed through wiring
Nominal current AC:	22 mA	Temperature ta:	-15...+40 °C

Available colours Add colour code to the article no. e.g. 800 014 LXX

Special colour: L99 

Articles

SNP 7186 LED J/SV

Art. no. 807 342

Wall mounting

Protection category: IP40

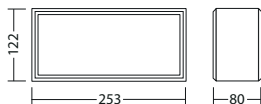



Double-sided aluminium profile emergency exit luminaires with additional light output at bottom side. Homogeneous illumination by state-of-the-art LED technology with a luminance of $> 500 \text{ cd/m}^2$.

Technical data

Viewing distance:	20 m	Nominal current DC:	18 mA
Material:	Aluminium	Apparent power:	6,1 VA
Illuminant:	LEDs	Inrush current:	8 A / 50 μs
Nominal voltage AC:	230V $\pm 10\%$ 50/60 Hz	Protection class:	I
Nominal voltage DC:	176 - 264 V	Input terminals:	2.5mm ² feed through wiring
Nominal current AC:	27 mA	Temperature ta:	-15...+40 °C

Available colours Add colour code to the article no. e.g. 800 014 LXX

Special colour: L99

Articles

SNP 7286 D LED J/SV

Art. no. 807 576

Ceiling mounting

Protection category: IP40

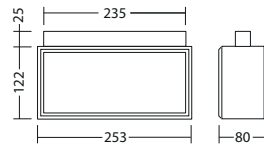

SNP 7286 K LED J/SV

Art. no. 807 577

Chain mounting

Protection category: IP40

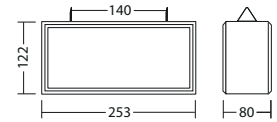

SNP 7286 P LED J/SV

Art. no. 807 578

Pendulum mounting

Protection category: IP40

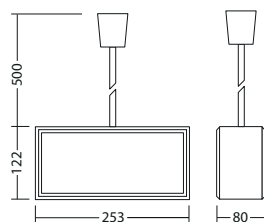

SNP 7286 WA LED J/SV

Art. no. 807 579

Wall bracket mounting

Protection category: IP40

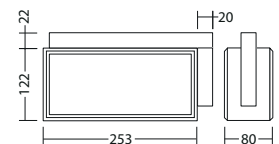



Single sided aluminium profile emergency exit luminaires with additional light output at bottom side. Homogeneous illumination by state-of-the-art LED technology with a luminance of $> 500 \text{ cd/m}^2$.

Technical data

Viewing distance:	35 m	Nominal current DC:	18 mA
Material:	Aluminium	Apparent power:	6,1 VA
Illuminant:	LEDs	Inrush current:	8 A / 50 μs
Nominal voltage AC:	230V $\pm 10\%$ 50/60 Hz	Protection class:	I
Nominal voltage DC:	176 - 264 V	Input terminals:	2.5mm ² feed through wiring
Nominal current AC:	27 mA	Temperature ta:	-15...+40 °C

Available colours Add colour code to the article no. e.g. 800 014 LXX

Special colour: L99 

Articles

SNP 7188 LED J/SV

Art. no. 807 372

Wall mounting

Protection category: IP40

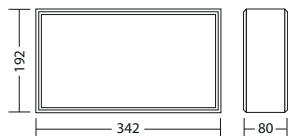



Double-sided aluminium profile emergency exit luminaires with additional light output at bottom side. Homogeneous illumination by state-of-the-art LED technology with a luminance of $> 500 \text{ cd/m}^2$.

Technical data

Viewing distance:	35 m	Nominal current DC:	32 mA
Material:	Aluminium	Apparent power:	8,3 VA
Illuminant:	LEDs	Inrush current:	8 A / 50 μs
Nominal voltage AC:	230V $\pm 10\%$ 50/60 Hz	Protection class:	I
Nominal voltage DC:	176 - 264 V	Input terminals:	2.5mm ² feed through wiring
Nominal current AC:	36 mA	Temperature ta:	-15...+40 °C

Available colours Add colour code to the article no. e.g. 800 014 LXX

Special colour: L99

Articles

SNP 7288 D LED J/SV

Art. no. 807 607

Ceiling mounting

Protection category: IP40

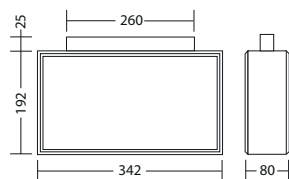

SNP 7288 K LED J/SV

Art. no. 807 618

Chain mounting

Protection category: IP40

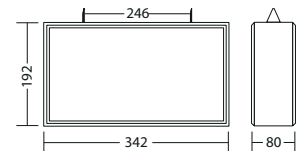

SNP 7288 P LED J/SV

Art. no. 807 617

Pendulum mounting

Protection category: IP40

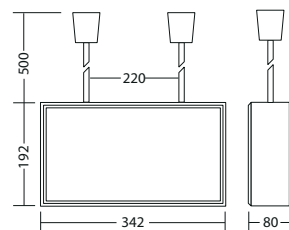

SNP 7288 S LED J/SV

Art. no. 807 610

Cable suspension mounting

Protection category: IP40

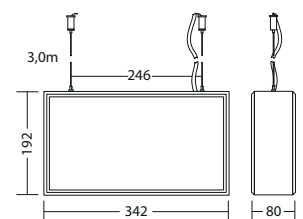

SNP 7288 WA LED J/SV

Art. no. 807 616

Wall bracket mounting

Protection category: IP40

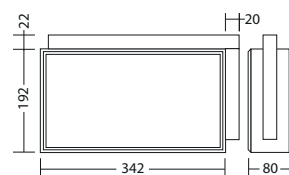



Single sided aluminium profile emergency exit luminaires with additional light output at bottom side. Homogeneous illumination by state-of-the-art LED technology with a luminance of $> 500 \text{ cd/m}^2$.

Technical data

Viewing distance:	60 m	Nominal current DC:	32 mA
Material:	Aluminium	Apparent power:	8,3 VA
Illuminant:	LEDs	Inrush current:	8 A / 50 μs
Nominal voltage AC:	230V $\pm 10\%$ 50/60 Hz	Protection class:	I
Nominal voltage DC:	176 - 264 V	Input terminals:	2.5mm ² feed through wiring
Nominal current AC:	36 mA	Temperature ta:	-15...+40 °C

Available colours Add colour code to the article no. e.g. 800 014 LXX

Special colour: L99 

Articles

SNP 7183 LED J/SV

Art. no. 807 327

Wall mounting

Protection category: IP40

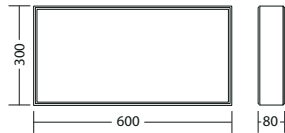



Double-sided aluminium profile emergency exit luminaires with additional light output at bottom side. Homogeneous illumination by state-of-the-art LED technology with a luminance of $> 500 \text{ cd/m}^2$.

Technical data

Viewing distance:	60 m	Nominal current DC:	60 mA
Material:	Aluminium	Apparent power:	14,0 VA
Illuminant:	LEDs	Inrush current:	8 A / 50 μs
Nominal voltage AC:	230V $\pm 10\%$ 50/60 Hz	Protection class:	I
Nominal voltage DC:	176 - 264 V	Input terminals:	2.5mm ² feed through wiring
Nominal current AC:	61 mA	Temperature ta:	-15...+40 °C

Available colours Add colour code to the article no. e.g. 800 014 LXX

Special colour: L99

Articles

SNP 7283 D LED J/SV

Art. no. 807 640

Ceiling mounting

Protection category: IP40

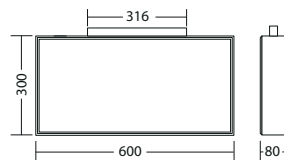

SNP 7283 K LED J/SV

Art. no. 807 649

Chain mounting

Protection category: IP40

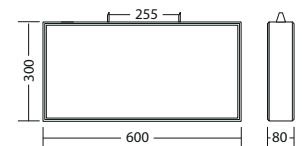

SNP 7283 P LED J/SV

Art. no. 807 646

Pendulum mounting

Protection category: IP40

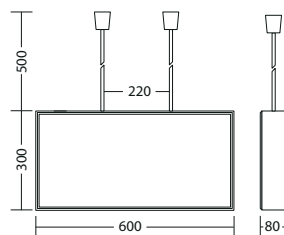

SNP 7283 S LED J/SV

Art. no. 807 528

Cable suspension mounting

Protection category: IP40

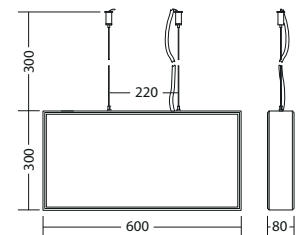

SNP 7283 WA LED J/SV

Art. no. 807 643

Wall bracket mounting

Protection category: IP40

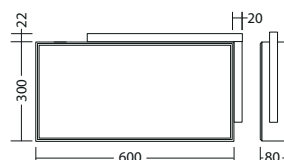





Single sided aluminium profile emergency exit luminaires for recessed wall mounting. Invisible frame with an installation depth of 60mm. Homogeneous illumination by state-of-the-art LED technology with a luminance of $> 500\text{cd/m}^2$.

Technical data

Viewing distance:	32 m	Nominal current DC:	18 mA
Material:	Aluminium	Apparent power:	6,1 VA
Illuminant:	LEDs	Inrush current:	8 A / 50 μs
Nominal voltage AC:	230V $\pm 10\%$ 50/60 Hz	Protection class:	I
Nominal voltage DC:	176 - 264 V	Input terminals:	2.5mm ² feed through wiring
Nominal current AC:	27 mA	Temperature ta:	-15...+40 °C

Available colours Add colour code to the article no. e.g. 800 014 LXX

Special colour: L99 

Articles

SNP 7168.1 LED J/SV

Art. no. 807 272

Recessed wall mounting

Protection category: IP40





Four-sided emergency exit sign luminaires

Thanks to their adaptable pictogram cover, the INOTEC emergency exit sign luminaires with four-sided light emission can be used for a wide range of applications and adapted to the escape route directions on site.

In addition to ceiling mounting with cable entry from the back, the installation box also offers the possibility of inserting cables from the side when routing cables on wall plaster or using wire or chain mounting.

The luminaires are available for two different viewing distances.



Advantages

- Reduced number of luminaires
- Easy assembly

Applications

- Storage areas
- Workplaces
- Shop premises



SNP 2420

127



SNP 2435

129





Four-sided emergency exit sign luminaire with anodized aluminium corner profile and multi-purpose installation box made of white UV- and filament resistant polycarbonate with optional side cable entry. Homogeneous pictogram illumination thanks to optimised LED technology with a luminance > 500 cd/m² and individually replaceable pictograms for each luminaire side.

Technical data

Viewing distance:	20 m	Apparent power:	4,4 VA
Material:	Polycarbonate	Effective power:	3,6 W
Illuminant:	LEDs	Inrush current:	8 A / 50 µs
Nominal voltage AC:	230V ±10% 50/60 Hz	Protection class:	II
Nominal voltage DC:	176 - 264 V	Input terminals:	2.5mm ² feed through wiring
Nominal current AC:	19 mA	Temperature ta:	-15...+40 °C
Nominal current DC:	16 mA		

Articles

SNP 2420 LED J/SV

Art. no. 802 640

Ceiling mounting

Protection category: IP54

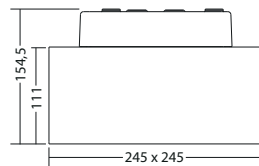

Ringbolts for SN 8500/24xx

Art. no. 890 403

optional accessories

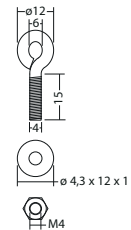

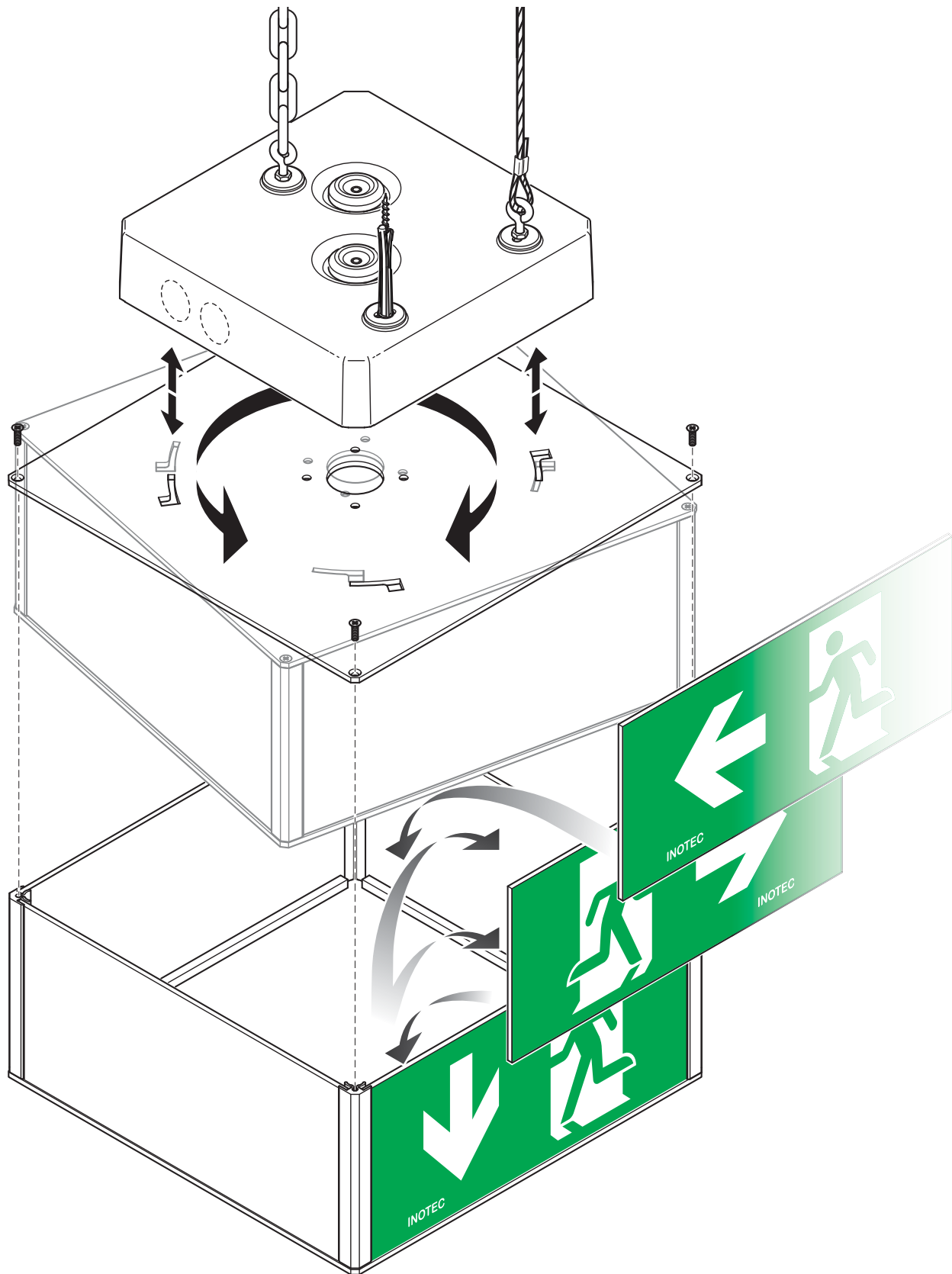



Four-sided emergency exit sign luminaire with anodized aluminium corner profile and multi-purpose installation box made of white UV- and filament resistant polycarbonate with optional side cable entry. Homogeneous pictogram illumination thanks to optimised LED technology with a luminance > 500 cd/m² and individually replaceable pictograms for each luminaire side.

Technical data

Viewing distance:	35 m	Apparent power:	7,6 VA
Material:	Polycarbonate	Effective power:	5,7 W
Illuminant:	LEDs	Inrush current:	8 A / 50 µs
Nominal voltage AC:	230V ±10% 50/60 Hz	Protection class:	II
Nominal voltage DC:	176 - 264 V	Input terminals:	2.5mm ² feed through wiring
Nominal current AC:	33 mA	Temperature ta:	-15...+40 °C
Nominal current DC:	25 mA		

Articles

SNP 2435 LED J/SV

Art. no. 802 642

Protection category: IP54

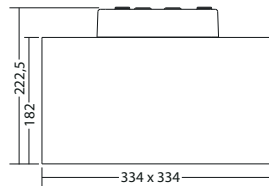

Ringbolts for SN 8500/24xx

Art. no. 890 403

optional accessories

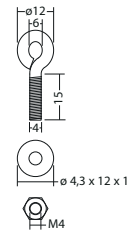



Wall and step luminaires

Safety and orientation luminaires

From top-quality LED step luminaires in stainless steel for the EN-compliant illumination of escape routes to luminaires with a high protection rating for emergency staircases (for instance): our range of wall and step luminaires contains something for every application.





Advantages

- Low power consumption
- Versatile mounting options
- Cutting-edge lighting technology

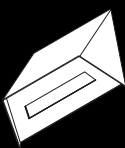
Areas of application

- Theatres
- Cinemas
- Staircases
- Lecture theatre
- etc.

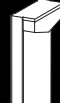

	SN 6110	132
	SN 6114	134
	SN 6204.2	137
	SN(P) 2004.1	140
	SN 6307	143



Rectangular LED safety luminaires to illuminate steps or escape routes. Recessed wall and stair mounting. Luminaire with powder-coated metal cover for installation in double wall box for concrete, cavity wall or in-wall.

Technical data

Material:	Sheet steel powder-coated	Nominal current DC:	18 mA
Illuminant:	LEDs	Apparent power:	6,1 VA
Luminous flux:	11 lm	Inrush current:	8 A / 50 μ s
Nominal voltage AC:	230V \pm 10% 50/60 Hz	Protection class:	I
Nominal voltage DC:	176 - 264 V	Input terminals:	2.5mm ² feed through wiring
Nominal current AC:	27 mA	Temperature ta:	-15...+40 °C

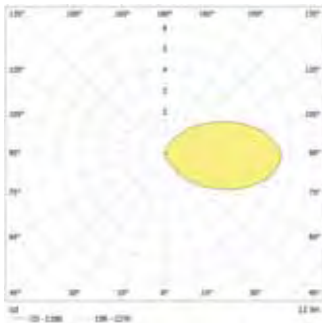

Articles

SN 6110 G LED J/SV rectangular, light output: grid

Art. no. 806 014

Recessed wall or stair mounting

Protection category: IP20

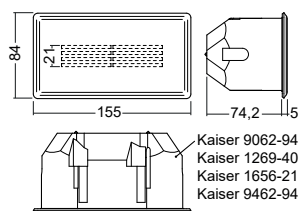



Rectangular LED safety luminaires to illuminate steps or escape routes. Recessed wall and stair mounting. Luminaire with powder-coated metal cover for installation in double wall box for concrete, cavity wall or in-wall.

Technical data

Material:	Sheet steel powder-coated	Nominal current DC:	18 mA
Illuminant:	LEDs	Apparent power:	6,1 VA
Luminous flux:	30 lm	Inrush current:	8 A / 50 μ s
Nominal voltage AC:	230V \pm 10% 50/60 Hz	Protection class:	I
Nominal voltage DC:	176 - 264 V	Input terminals:	2.5mm ² feed through wiring
Nominal current AC:	27 mA	Temperature ta:	-15...+40 °C

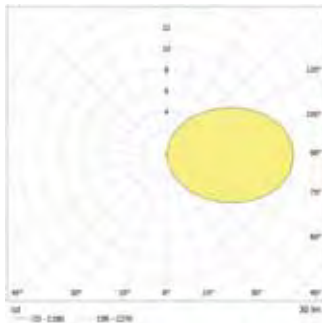

Articles

SN 6110 O LED J/SV rectangular, light output: opal

Art. no. 806 011

Recessed wall or stair mounting

Protection category: IP20

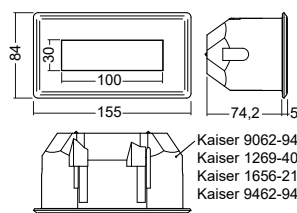



Robust LED safety luminaires to illuminate steps or escape routes. Recessed wall and stair mounting. Made of high-quality die-cast aluminium with high protection category.

Technical data

Material:	Die-cast aluminum	Nominal current DC:	25 mA
Illuminant:	LEDs	Apparent power:	7,1 VA
Luminous flux:	25 lm	Inrush current:	8 A / 50 μ s
Nominal voltage AC:	230V \pm 10% 50/60 Hz	Protection class:	I
Nominal voltage DC:	176 - 264 V	Input terminals:	2.5mm ² feed through wiring
Nominal current AC:	31 mA	Temperature ta:	-15...+40 °C

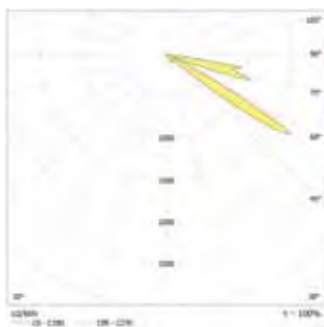

Articles

SN 6114 G LED J/SV grids

Art. no. 806 025

Recessed wall or stair mounting

Protection category: IP54

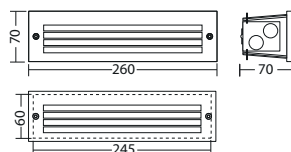



Robust LED safety luminaires to illuminate steps or escape routes. Recessed wall and stair mounting. Made of high-quality die-cast aluminium with high protection category.

Technical data

Material:	Die-cast aluminum	Nominal current DC:	25 mA
Illuminant:	LEDs	Apparent power:	7,1 VA
Luminous flux:	93 lm	Inrush current:	8 A / 50 μ s
Nominal voltage AC:	230V \pm 10% 50/60 Hz	Protection class:	I
Nominal voltage DC:	176 - 264 V	Input terminals:	2.5mm ² feed through wiring
Nominal current AC:	31 mA	Temperature ta:	-15...+40 °C

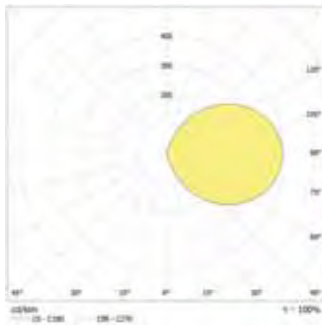

Articles

SN 6114 O LED J/SV

Art. no. 806 024

Recessed wall or stair mounting

Protection category: IP54

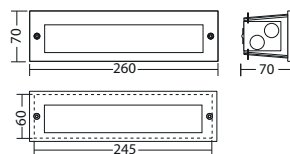



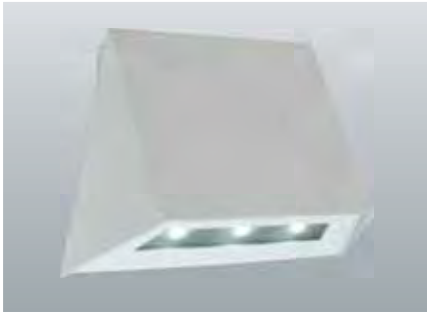

Trapezoidal LED emergency luminaires for illumination of escape routes and exit doors. Luminaires for wall mounting with elegant powder coated metal housing without any visible screws.



Technical data

Material:	Sheet steel powder-coated
Illuminant:	LEDs
Luminous flux:	210 lm
Nominal voltage AC:	230V ±10% 50/60 Hz
Nominal voltage DC:	176 - 264 V
Nominal current AC:	31 mA

Nominal current DC:	25 mA
Apparent power:	7,1 VA
Inrush current:	8 A / 50 µs
Protection class:	I
Input terminals:	2.5mm ² feed through wiring
Temperature ta:	-15...+40 °C

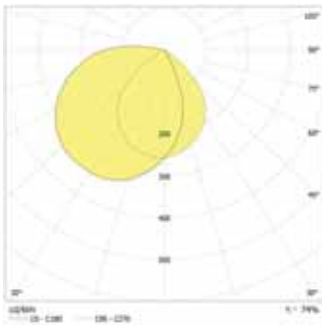

Minimum illumination 1.0 lx (middle of escape route), Maintenance factor 0.8

Distance to middle of escape route [m]	Distance to middle of escape route					
	1.0m		2.0m		3.0m	
1.0	2.2	5.4	2.3	5.7	1.8	5.2
2.0	2.8	7.0	2.8	7.2	2.3	6.8
2.5	3.0	7.4	3.0	7.8	2.6	7.4
3.0	3.1	8.0	3.1	8.4	2.7	8.1
3.5	3.2	8.5	3.2	8.7	2.8	8.5
4.0	3.1	8.7	3.1	9.1	2.8	8.8
4.5	3.0	9.0	3.0	9.3	2.7	9.0
5.0	2.8	9.0	2.8	9.3	2.5	9.1
5.5	2.6	9.0	2.6	9.3	2.0	9.1
6.0	2.2	8.8	2.1	9.2	1.5	8.9

Available colours Add colour code to the article no. e.g. 800 014 LXX

RAL 9016 (Traffic white): **L04** RAL 7015 (Slate grey): **L16** Special colour: **L99**

Articles

SN 6204.1 LED J/SV Art. no. 806 412

Wall mounting

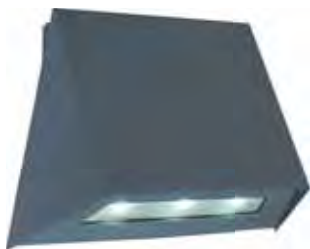

Protection category: IP40

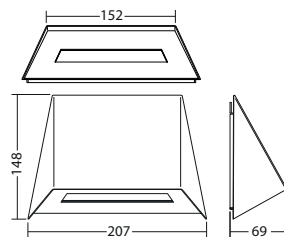

SN 6204.1 LED J/SV Art. no. 806 412

Wall mounting



Protection category: IP40

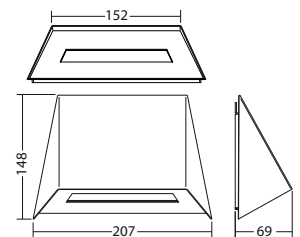

mounting adapter SN 6204.1 IP40, RAL 9016 Art. no. 890 731 L04

optional accessories

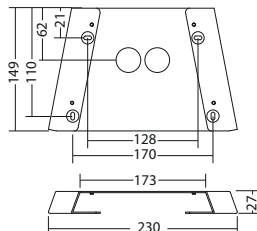



Combined safety and safety sign luminaire

Fire fighting and first aid facilities have to be specially marked and illuminated by 5lux according to EN 1838 of October 2013. The direct surrounding (distance of min. 2 meter) has to be illuminated as well.

The new combined safety and safety sign luminaire SNP 2004.1 is the ideale luminaire to indicate and illuminate areas with fire fighting equipment, first aid stations and other important areas.

Compared to an illuminated sign, back-lit emergency signs have the benefit of a very good visibility in bright surroundings due to their luminance of $> 500\text{cd/m}^2$. Fire fighting equipment and first aid facilities can be located very quickly in emergency situations. The integrated safety light will be switched on in case of a mains failure and illuminates the respective area according to the standards.

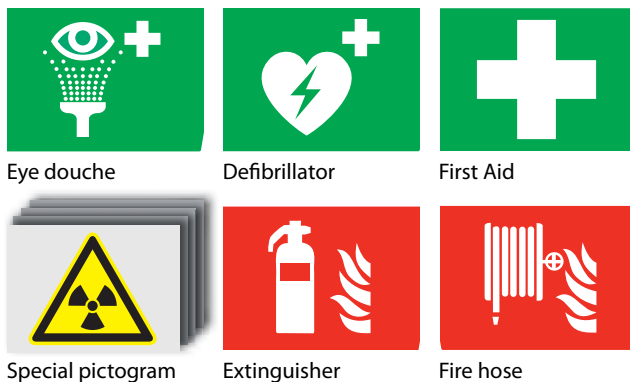



Versatile LED safety luminaire ideal for illumination of areas to be highlighted especially according to DIN EN 1838. Luminaire with separately switchable, backlit pictograph. UV resistant, heat filament tested polycarbonate housing for wall mounting with optional side cable entry.



Technical data

Viewing distance:	18 m	Nominal current DC:	43 mA
Material:	Polycarbonate	Apparent power:	13,2 VA
Illuminant:	LEDs	Inrush current:	6 A / 98 μ s
Nominal voltage AC:	230V \pm 10% 50/60 Hz	Protection class:	II
Nominal voltage DC:	176 - 264 V	Input terminals:	2.5mm ² feed through wiring
Nominal current AC:	57 mA	Temperature ta:	-15...+40 °C

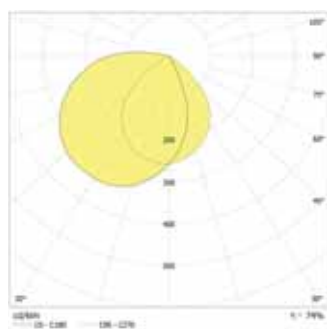

Minimum illumination 1.0 lx (middle of escape route), Maintenance factor 0.8

Distance to middle of escape route	Distance to middle of escape route					
	1.0m		2.0m		3.0m	
1.0	2.2	5.4	2.3	5.7	1.8	5.2
2.0	2.8	7.0	2.8	7.2	2.3	6.8
2.5	3.0	7.4	3.0	7.8	2.6	7.4
3.0	3.1	8.0	3.1	8.4	2.7	8.1
3.5	3.2	8.5	3.2	8.7	2.8	8.5
4.0	3.1	8.7	3.1	9.1	2.8	8.8
4.5	3.0	9.0	3.0	9.3	2.7	9.0
5.0	2.8	9.0	2.8	9.3	2.5	9.1
5.5	2.6	9.0	2.6	9.3	2.0	9.1
6.0	2.2	8.8	2.1	9.2	1.5	8.9

Articles

SNP 2004.1 LED J/SV

Art. no. 802 145 .1V

Wall mounting

Protection category: IP40

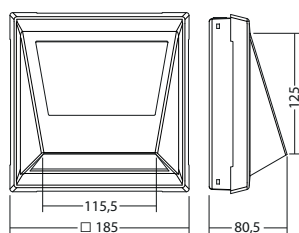

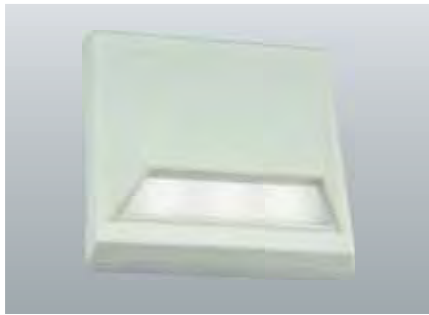

Versatile LED safety luminaire ideal for escape route or staircase illumination. UV resistant, heat filament tested polycarbonate housing for wall mounting with optional side cable entry.

Technical data

Material:	Polycarbonate	Nominal current DC:	25 mA
Illuminant:	LEDs	Apparent power:	7,1 VA
Luminous flux:	210 lm	Inrush current:	8 A / 50 μ s
Nominal voltage AC:	230V \pm 10% 50/60 Hz	Protection class:	II
Nominal voltage DC:	176 - 264 V	Input terminals:	2.5mm ² feed through wiring
Nominal current AC:	31 mA	Temperature ta:	-15...+40 °C

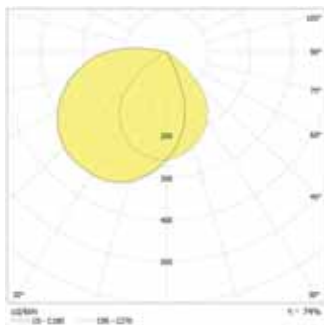

Minimum illumination 1.0 lx (middle of escape route), Maintenance factor 0.8

Distance to middle of escape route [m]	Distance to middle of escape route					
	1.0m		2.0m		3.0m	
1.0	2.2	5.4	2.3	5.7	1.8	5.2
2.0	2.8	7.0	2.8	7.2	2.3	6.8
2.5	3.0	7.4	3.0	7.8	2.6	7.4
3.0	3.1	8.0	3.1	8.4	2.7	8.1
3.5	3.2	8.5	3.2	8.7	2.8	8.5
4.0	3.1	8.7	3.1	9.1	2.8	8.8
4.5	3.0	9.0	3.0	9.3	2.7	9.0
5.0	2.8	9.0	2.8	9.3	2.5	9.1
5.5	2.6	9.0	2.6	9.3	2.0	9.1
6.0	2.2	8.8	2.1	9.2	1.5	8.9

Articles

SN 2004.1 LED J/SV

Art. no. 802 137 .1

Wall mounting

Protection category: IP40

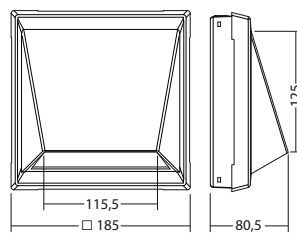





Elegant LED bollard luminaire ideal for outdoor escape route illumination made of powder-coated aluminium with high protection category.

Technical data

Material:	Aluminium powder-coated
Illuminant:	LEDs
Luminous flux:	178 lm
Nominal voltage AC:	230V ±10% 50/60 Hz
Nominal voltage DC:	176 - 264 V
Nominal current AC:	36 mA

Nominal current DC:	32 mA
Apparent power:	8,3 VA
Inrush current:	8 A / 50 µs
Protection class:	II
Input terminals:	2.5mm ² feed through wiring
Temperature ta:	-15...+40 °C

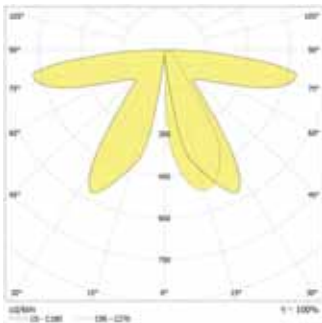

Minimum illumination 1.0 lx (middle of escape route), Maintenance factor 0.8

0.85	4.0	10.4

Articles

SN 6307 LED J/SV

Art. no. 806 308

Floor installation



Protection category: IP54

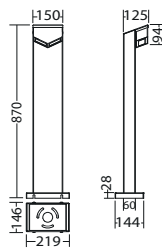

ground element bollard console

Art. no. 040 821

optional accessories



Protection category: IP54

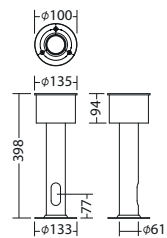



Stainless steel luminaires

Robust luminaire with high protection rating

INOTEC stainless steel luminaires are used wherever high degrees of protection and robust luminaire designs are required. The luminaires are available with fluorescent lamps or state-of-the-art LED technology.

Advantages

- Robust stainless steel housing A4 brushed
- Protection degree IP54 / IP65

Applications

- Food industry
- Work places with high demands
- Outdoor areas
- Carparks
- etc.



SNP 818 147



SNP 808 148



SNP 828 149



SN 804.1 WT 153



SN 804.1 155





Single sided emergency exit luminaires made of robust, brushed stainless steel with high protection category. Homogeneous illumination by state-of-the-art LED technology with a luminance of $>500\text{cd/m}^2$. Suitable for use in food industry or food processing plants with high demands on product hygiene.

Technical data

Viewing distance:	17 m	Nominal current DC:	18 mA
Material:	Stainless steel brushed	Apparent power:	6,1 VA
Illuminant:	LEDs	Inrush current:	8 A / 50 μs
Nominal voltage AC:	230V $\pm 10\%$ 50/60 Hz	Protection class:	I
Nominal voltage DC:	176 - 264 V	Input terminals:	2.5mm ² feed through wiring
Nominal current AC:	27 mA	Temperature ta:	-15...+40 °C

Available colours Add colour code to the article no. e.g. 800 014 LXX

stainless steel: L30  Special colour: L99 

Articles

SNP 818 LED J/SV

Art. no. 808 818

Wall mounting

Protection category: IP54

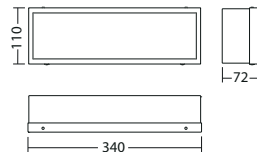



Single sided emergency exit luminaires made of robust, brushed stainless steel with high protection category. Homogeneous illumination by state-of-the-art LED technology with a luminance of >500cd/m². Suitable for use in food industry or food processing plants with high demands on product hygiene.

Technical data

Viewing distance:	30 m	Nominal current DC:	18 mA
Material:	Stainless steel brushed	Apparent power:	6,1 VA
Illuminant:	LEDs	Inrush current:	8 A / 50 µs
Nominal voltage AC:	230V ±10% 50/60 Hz	Protection class:	I
Nominal voltage DC:	176 - 264 V	Input terminals:	2.5mm ² feed through wiring
Nominal current AC:	27 mA	Temperature ta:	-15...+40 °C

Available colours Add colour code to the article no. e.g. 800 014 LXX

stainless steel: **L30** ■ Special colour: **L99** ■

Articles

SNP 808 LED J/SV

Art. no. 808 817

Wall mounting

Protection category: IP65

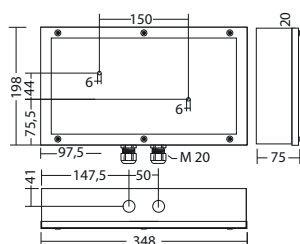



Double-sided emergency exit luminaires made of robust, brushed stainless steel with high protection category. Homogeneous illumination by state-of-the-art LED technology with a luminance of $>500\text{cd/m}^2$. Suitable for use in food industry or food processing plants with high demands on product hygiene.



Technical data

Viewing distance:	30 m	Nominal current DC:	32 mA
Material:	Stainless steel brushed	Apparent power:	8,3 VA
Illuminant:	LEDs	Inrush current:	8 A / 50 μs
Nominal voltage AC:	230V $\pm 10\%$ 50/60 Hz	Protection class:	I
Nominal voltage DC:	176 - 264 V	Input terminals:	2.5mm ² feed through wiring
Nominal current AC:	36 mA	Temperature ta:	-15...+40 °C

Available colours Add colour code to the article no. e.g. 800 014 LXX

stainless steel: L30 ■ Special colour: L99 ■

Articles

SNP 828 K LED J/SV

Art. no. 808 863

Chain mounting

Protection category: IP65

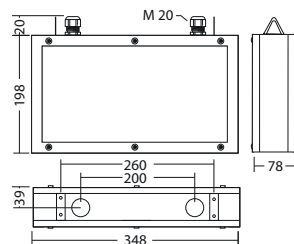

SNP 828 WA LED J/SV

Art. no. 808 868

Wall bracket mounting

Protection category: IP65

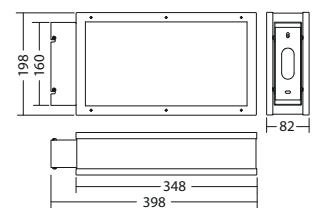





Standard-compliant safety lighting - up to the safe area



Safety lighting outside buildings up to a safe area, as required by EN 1838, is often difficult to provide. The supply of general lighting in outdoor areas or mast luminaires with high output is related to a bigger system as well as a higher battery capacity and therefore is very costly.

The new bollard luminaire SN 6307 is the ideal luminaire to illuminate outdoor areas due to its low power consumption and the high degree of protection IP54. The optimised light technology allows distances between two luminaires of more than 10m.

The new safety luminaire SN 804.1 WT is an alternative if it's not possible to use a bollard luminaire due to the structural design of a building. This luminaire illuminates the escape route with 1 lux at mounting heights of up to 32m. This means that the luminaire can be mounted unobtrusively at high altitudes. The practical, lockable mounting bracket can be used for adjusting the luminaire to the corresponding escape area.





Robust stainless steel luminaires for illuminating surfaces and escape routes. Luminaire made of brushed stainless steel with high protection class and special low beam optics for suspension heights up to 32m.

Technical data

Material:	Stainless steel brushed	Nominal current DC:	32 mA
Illuminant:	LEDs	Apparent power:	8,3 VA
Luminous flux:	339 lm	Inrush current:	8 A / 50 µs
Nominal voltage AC:	230V ±10% 50/60 Hz	Protection class:	I
Nominal voltage DC:	176 - 264 V	Input terminals:	2.5mm ² feed through wiring
Nominal current AC:	36 mA	Temperature ta:	-15...+40 °C

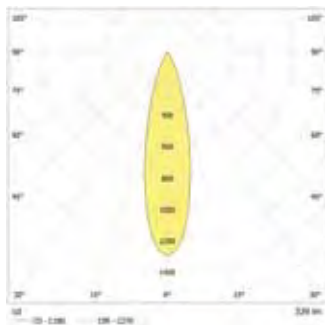

Minimum illumination 1.0 lx (middle of escape route), Maintenance factor 0.8

[m]	4.6	11.1
11.0	4.6	11.1
12.0	4.7	11.5
14.0	4.9	12.5
16.0	5.0	13.2
18.0	5.0	13.7
20.0	5.0	14.0
22.0	4.9	14.2
24.0	4.6	14.3
26.0	4.2	14.3
28.0	3.7	14.1
30.0	2.9	14.1
32.0	0.9	13.6

Minimum illumination 1.0 Lux (area illumination), Maintenance factor 0.8

[m]	3.3	9.0
11.0	3.3	9.0
12.0	3.6	9.5
14.0	3.7	10.3
16.0	3.7	11.1
18.0	3.7	11.8
20.0	3.7	12.2
22.0	3.6	12.7
24.0	3.6	12.8
26.0	3.5	12.8
28.0	3.2	12.4
30.0	3.0	12.2
32.0	2.8	12.1

Available colours Add colour code to the article no. e.g. 800 014 LXX

stainless steel: **L30** ■ Special colour: **L99** ■

Articles

SN 804.1 W T LED J/SV

Art. no. 808 181

Wall bracket mounting

Protection category: IP65

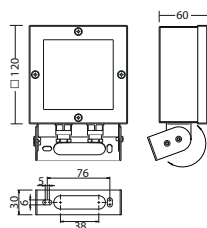





Robust brushed stainless steel luminaires with high protection category and latest LED-technology for area or escape route illumination. Suitable for use in food industry or food processing plants with high demands on product hygiene.

Technical data

Material:	Stainless steel brushed	Nominal current DC:	32 mA
Illuminant:	LEDs	Apparent power:	8,3 VA
Luminous flux:	310 lm	Inrush current:	8 A / 50 µs
Nominal voltage AC:	230V ±10% 50/60 Hz	Protection class:	I
Nominal voltage DC:	176 - 264 V	Input terminals:	2.5mm ² feed through wiring
Nominal current AC:	36 mA	Temperature ta:	-15...+40 °C

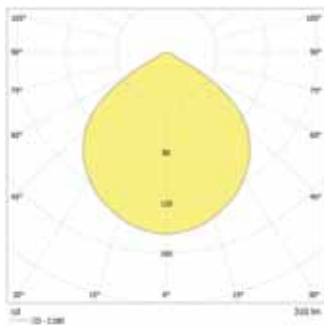

Minimum illumination 1.0 lx (middle of escape route), Maintenance factor 0.8

(m)	3.7	8.5
2.5	3.7	8.5
3.0	4.1	9.7
4.0	4.7	11.5
5.0	5.0	12.9
6.0	5.1	13.9
7.0	4.9	14.3
8.0	4.5	14.4
9.0	3.7	14.3
10.0	2.5	13.8

Minimum illumination 1.0 Lux (area illumination), Maintenance factor 0.8

(m)	2.7	6.4
2.5	2.7	6.4
3.0	3.1	7.3
4.0	3.6	9.0
5.0	3.7	10.6
6.0	3.7	11.8
7.0	3.6	12.4
8.0	3.4	12.8
9.0	3.1	12.6
10.0	2.6	12.4

Available colours Add colour code to the article no. e.g. 800 014 LXX

stainless steel: **L30** ■ Special colour: **L99** ■

Articles

SN 804.1 AP LED J/SV

Art. no. 808 471

ceiling mounting for exposed wiring

Protection category: IP65

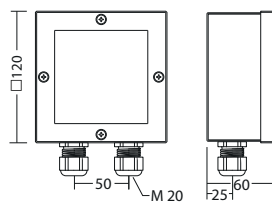

SN 804.1 D LED J/SV

Art. no. 808 451

Ceiling mounting

Protection category: IP65

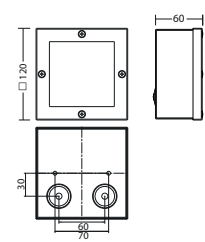

SN 804.1 E LED J/SV

Art. no. 808 461

Recessed ceiling mounting

Protection category: IP65

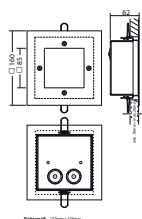

SN 804.1 W LED J/SV

Art. no. 808 441

Wall bracket mounting

Protection category: IP65

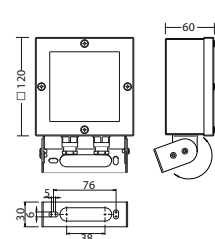



Downlights

Powerful and versatile







INOTEC offers a wide range of downlights. Versatile mounting and fastening options offer the ideal solution for every application.

Advantages

- Low power consumption
- Easy installation
- State-of-the-art lighting technology

Applications

- Public buildings
- Workplaces
- High-bay warehouses
- Conference facilities
- Hotels
- Office buildings
- Shop premises
- etc.

	SN 9100 TES	159
	SN 9400	165
	SN 8400	171
	SN 8500	185
	SN 8040	191
	SN 2040.1	195



High-quality aluminium recessed downlight with INOTEC TES technology

The elegant and compact recessed downlight SN 9100 made of high-quality aluminium can be discreetly and unobtrusively integrated into almost any ceiling mirror.

The new INOTEC TES technology (Translucent-Emitting-Surface) ensures 20% higher luminous efficiency at the same power consumption compared to conventional warm-white power LEDs. A backlit, light-emitting disc produces a rotationally symmetrical and uniform radiation characteristic.

The SN 9100 is optionally available in three different light colours (2700K, 3500K and 4300K) and is not only suitable as a safety luminaire, but also fulfils all requirements for convenient passage lighting.

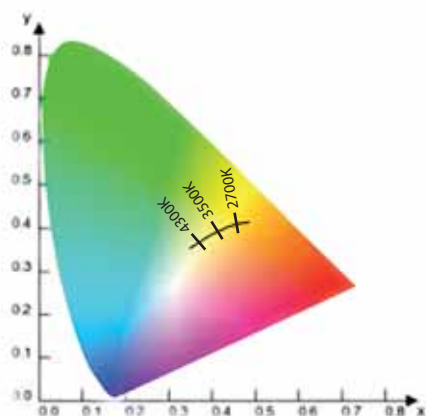
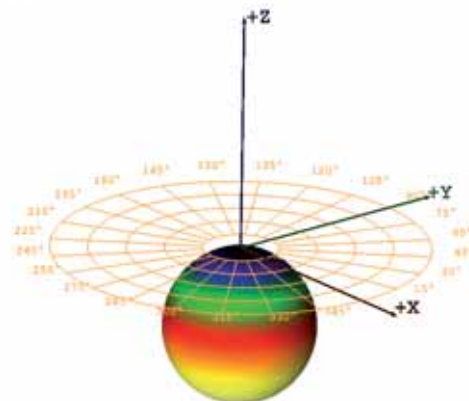



High-quality LED downlight, ideal for area or escape route illumination. Perfect for combined usage of safety and general lighting. Possible adaption to the light colour of the general lighting by Translucent-Emitting-Surface (TES) technology. Powder-coated aluminium housing without any visible screws designed for tool-less recessed ceiling installation in a ceiling cut-out Ø 72mm.

Technical data

Material:	Aluminium powder-coated	Nominal current DC:	32 mA
Illuminant:	LEDs	Apparent power:	8,3 VA
Luminous flux:	261 lm	Inrush current:	8 A / 50 µs
Nominal voltage AC:	230V ±10% 50/60 Hz	Protection class:	II
Nominal voltage DC:	176 - 264 V	Input terminals:	2.5mm ² feed through wiring
Nominal current AC:	36 mA	Temperature ta:	-15...+40 °C

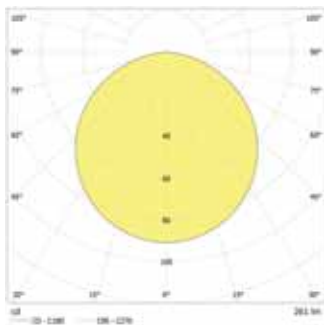

Minimum illumination 1.0 lx (middle of escape route), Maintenance factor 0.8

Beam diameter [m]	Beam diameter [m]	Beam diameter [m]
2.5	3.7	9.4
3.0	3.8	10.1
4.0	4.1	11.0
5.0	4.1	11.6
6.0	3.8	11.7

Minimum illumination 1.0 Lux (area illumination), Maintenance factor 0.8

Beam diameter [m]	Beam diameter [m]	Beam diameter [m]
2.5	2.5	8.0
3.0	2.7	8.6
4.0	2.7	9.8
5.0	2.7	10.6
6.0	2.7	10.6

Available colours Add colour code to the article no. e.g. 800 014 LXX

RAL 9016 (Traffic white): **L04** Special colour: **L99**

Articles

SN 9100 LED J/SV round

Art. no. 809 001

Recessed ceiling mounting Light colour: 2700 K Protection category: IP20

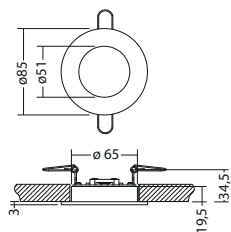

SN 9100 LED J/SV round

Art. no. 809 002

Recessed ceiling mounting Light colour: 3500 K Protection category: IP20

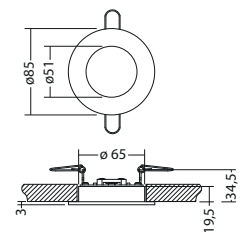

SN 9100 LED J/SV round

Art. no. 809 003

Recessed ceiling mounting Light colour: 4300 K Protection category: IP20

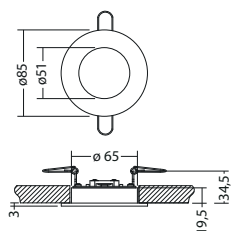

LED-Supply 230-3 J-SV SK II ext.

Art. no. 890 490

required

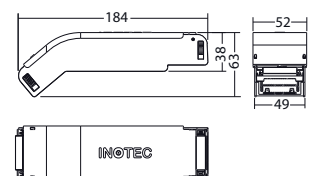



New downlight series for greater safety and efficiency

The housings of the new INOTEC downlight series are made from high-quality powder-coated die-cast aluminium.

The discreet design allows the LED emergency luminaires to be unobtrusively integrated into the architecture of the building.

A highly efficient power LED of the latest generation combined with excellent thermal management ensures a luminous flux of more than 160 lm/W.

In addition, the multi-chip LED used offers a higher level of safety. With INOTEC FUSION CPS and CLS emergency lighting systems, even the failure of a single chip can be detected.

Thanks to different secondary optics, the luminous flux of the LED is used optimally.

Thus escape routes or areas with various mounting heights are illuminated efficiently.

Particular focus was placed on practice-oriented spacings between safety luminaires at the lowest possible power consumption.

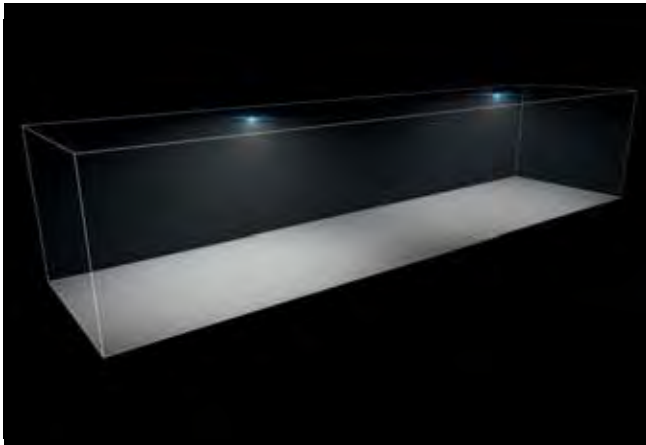

ALB - Asymmetric Low Bay

Luminaires with asymmetrical light distribution ALB are particularly suitable for escape routes with low mounting heights.

The light distribution is designed to illuminate escape routes efficiently and in compliance with regulations.



AHB - Asymmetric High Bay

Luminaires with asymmetrical light distribution AHB are particularly suitable for escape routes with high mounting heights.

The light distribution is designed to illuminate escape routes efficiently and in compliance with regulations.

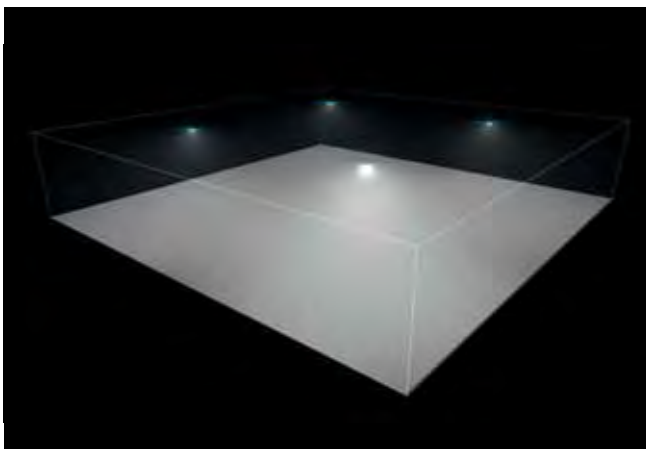

SLB - Symmetric Low Bay

Luminaires with symmetrical light distribution SLB are particularly suitable for escape routes with low mounting heights.

The light distribution is designed to illuminate escape routes efficiently and in compliance with regulations.

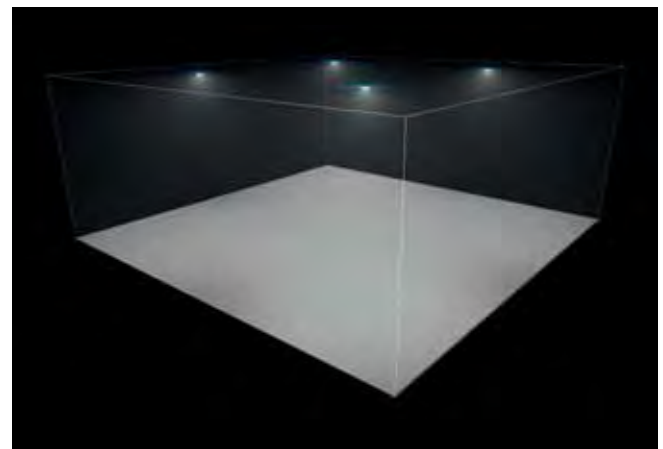

SHB - Symmetric High Bay

Luminaires with symmetrical light distribution SHB are particularly suitable for escape routes with high mounting heights.

The light distribution is designed to illuminate escape routes efficiently and in compliance with regulations.



Illuminate places to be highlighted in accordance to the standards

EN 1838 requires safety lighting in places to be highlighted. A higher lighting level is specified for first-aid stations, fire-fighting and alarm equipment.

In order to provide adequate visual conditions in the event of a power failure, the vertical illuminance at these devices has to be 5lx.

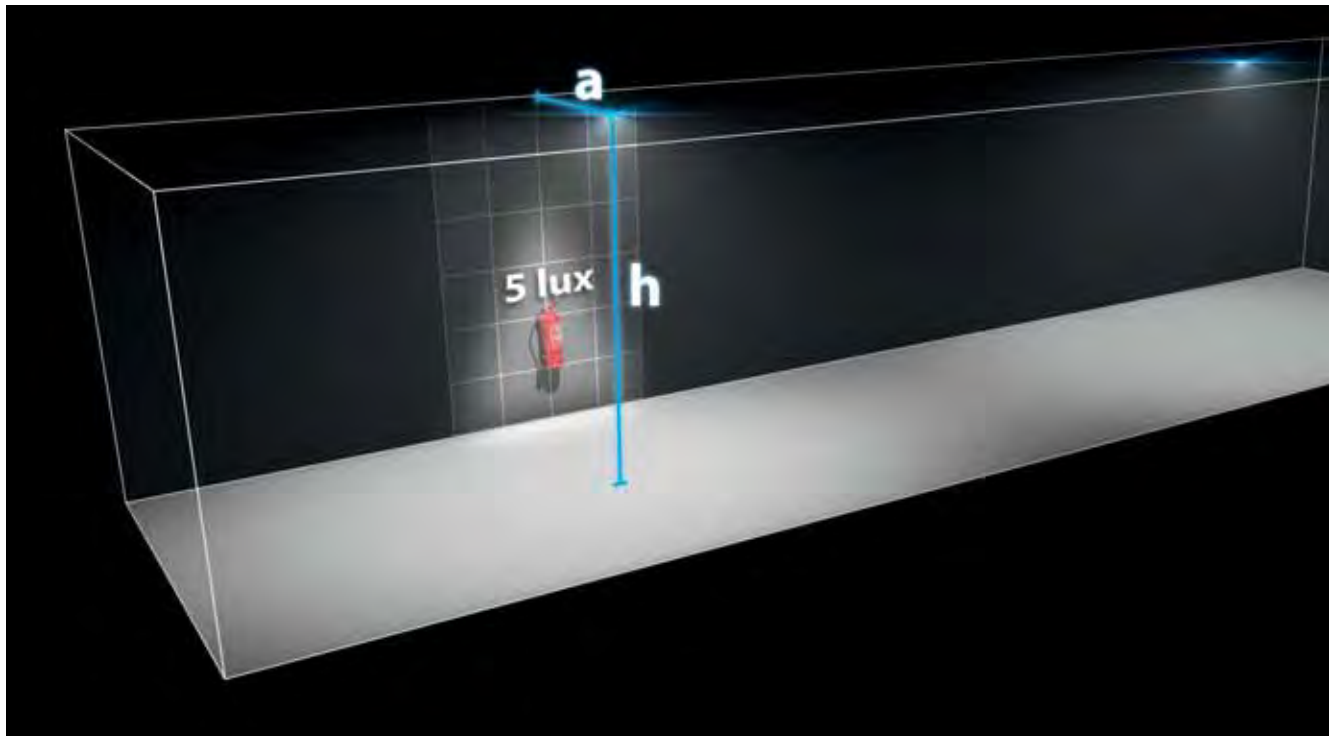

AHB –for 5lx in places to be highlighted

The luminaires with asymmetrical light distribution for high mounting heights AHB can be mounted crosswise to the escape route and used as safety luminaires for places to be highlighted with an illuminance of 5 lx.

Distance Wall – Luminaire (a)

0,75 m = —

1,00 m = —

1,50 m = —

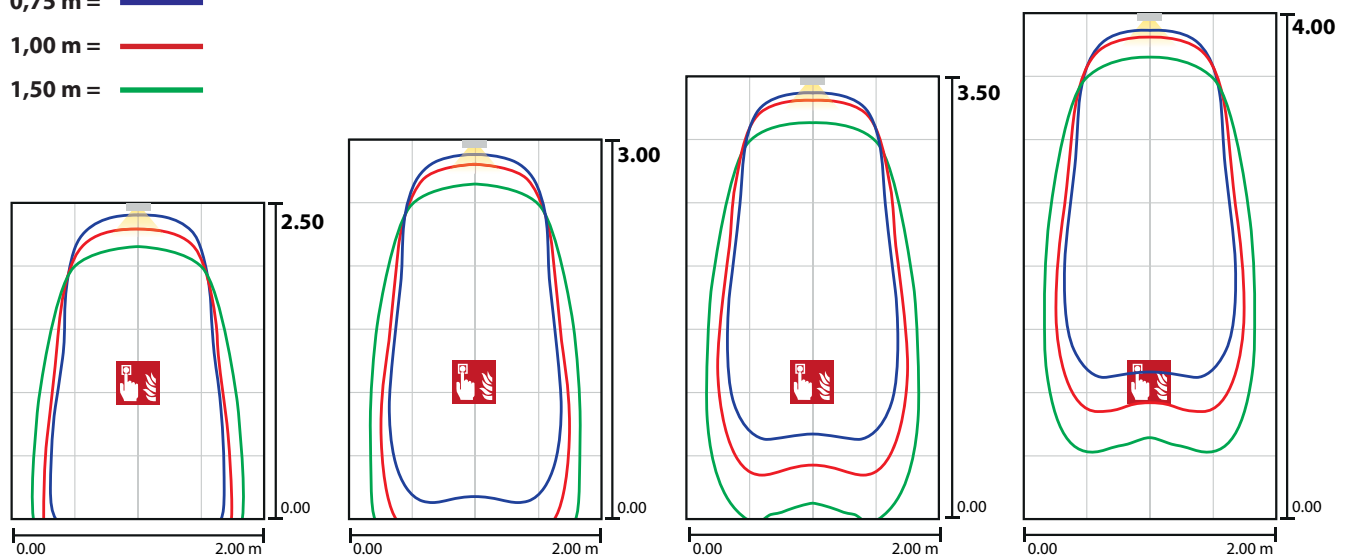

Versatile installation

The SN 9400 luminaire series can be mounted quickly and easily in suspended ceilings using the proven mounting springs. The heatsink has been particularly engineered to ensure efficient heat dissipation and thus a long service life of the LEDs.

The SN 9400 is also suitable for installation in the HaloX-O concrete housing with Kaiser transformer tunnel. In this way, these safety luminaires can be installed in concrete ceilings that have been constructed using the in-situ concrete method or in factory production.

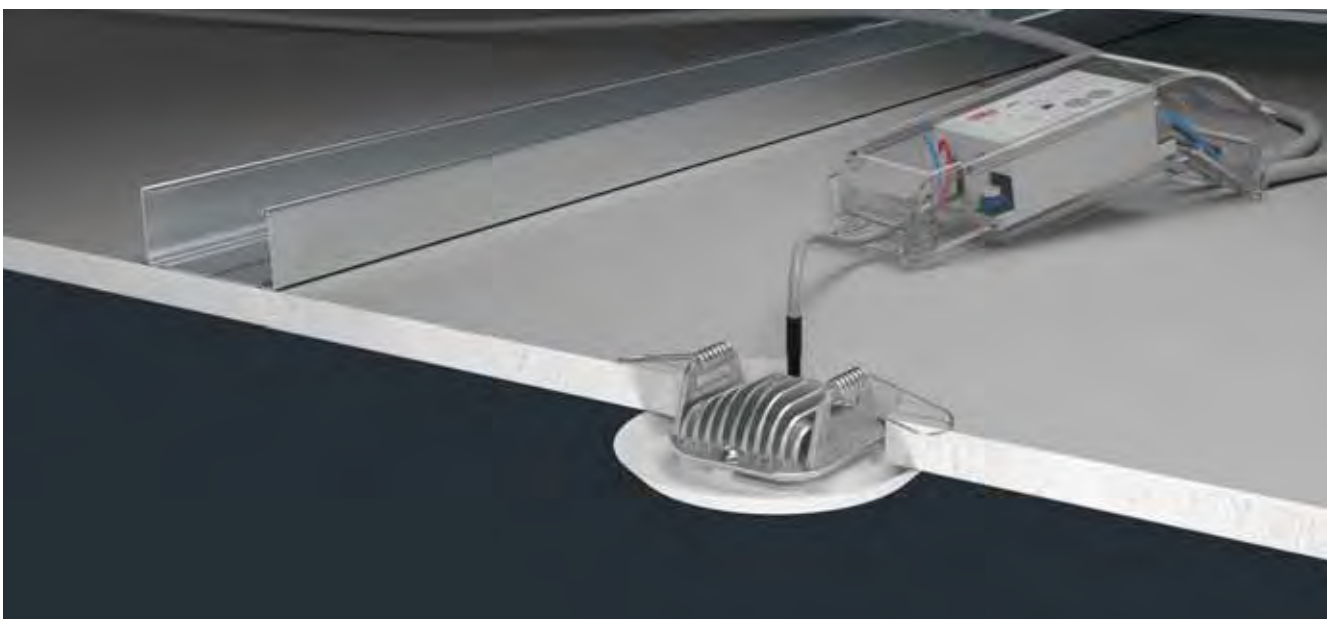

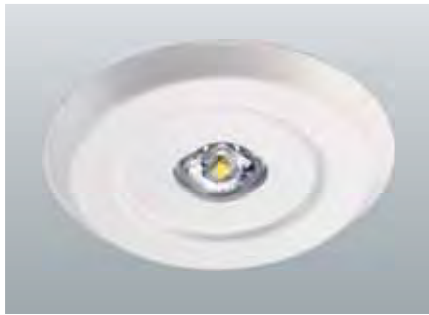

LED safety luminaire with optimised light distribution for the illumination of spaces. Housing made of powder-coated aluminium for installation in Ø 68mm ceiling cutout. Incl. 4-chip LED illuminant for maximum safety.

Technical data

Material:	Die-cast aluminum powder-coated	Apparent power:	7,6 VA
Illuminant:	LEDs	Effective power:	5,7 W
Luminous flux:	517 lm	Inrush current:	8 A / 50 µs
Nominal voltage AC:	230V ±10% 50/60 Hz	Protection class:	II
Nominal voltage DC:	176 - 264 V	Input terminals:	2.5mm ² feed through wiring
Nominal current AC:	33 mA	Temperature ta:	-15...+40 °C
Nominal current DC:	25 mA		

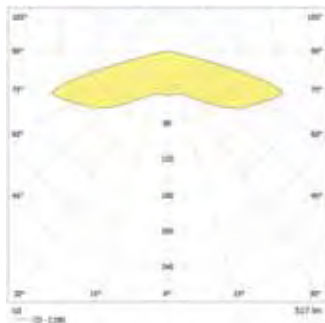

Minimum illumination 1.0 lx (middle of escape route), Maintenance factor 0.8

Distance (m)	2.5	3.0	3.5	4.0	4.5	5.0	5.5	6.0
2.5	5.9	5.9	5.9	5.9	5.9	5.9	5.9	5.9
3.0	5.9	16.3	5.9	5.9	5.9	5.9	5.9	5.9
3.5	5.9	16.7	16.7	5.9	5.9	5.9	5.9	5.9
4.0	5.8	16.9	16.9	16.9	5.9	5.9	5.9	5.9
4.5	5.6	16.8	16.8	16.8	16.8	5.9	5.9	5.9
5.0	5.0	16.7	16.7	16.7	16.7	16.7	5.9	5.9
5.5	3.8	16.4	16.4	16.4	16.4	16.4	16.4	5.9
6.0	1.4	16.2	16.2	16.2	16.2	16.2	16.2	16.2

Minimum illumination 1.0 Lux (area illumination), Maintenance factor 0.8

Distance (m)	2.5	3.0	3.5	4.0	4.5	5.0	5.5	6.0
2.5	12.6	12.6	12.6	12.6	12.6	12.6	12.6	12.6
3.0	4.9	14.0	4.9	4.9	4.9	4.9	4.9	4.9
3.5	5.0	14.9	14.9	5.0	5.0	5.0	5.0	5.0
4.0	4.6	15.5	15.5	15.5	5.0	5.0	5.0	5.0
4.5	4.1	15.1	15.1	15.1	15.1	5.0	5.0	5.0
5.0	3.9	14.5	14.5	14.5	14.5	14.5	5.0	5.0
5.5	3.7	14.3	14.3	14.3	14.3	14.3	14.3	5.0
6.0	3.5	14.1	14.1	14.1	14.1	14.1	14.1	14.1

Available colours Add colour code to the article no. e.g. 800 014 LXX

RAL 9016 (Traffic white): **L04** Special colour: **L99**

Articles

SN 9400-12 SLB LED J/SV round

Art. no. 809 440

Recessed ceiling mounting Light colour: 4000 K Protection category: IP20

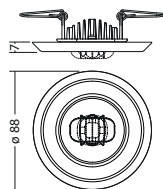

SN 9400-12 SLB LED J/SV square

Art. no. 809 444

Recessed ceiling mounting Light colour: 4000 K Protection category: IP20

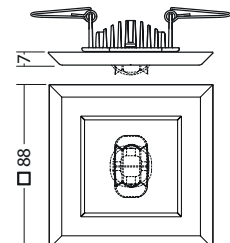

LED-Supply 230-3 J-SV SK II ext.

Art. no. 890 490

required

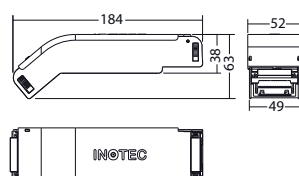



LED safety luminaire with optimised light distribution for the illumination of spaces with high mounting heights. Housing made of powder-coated aluminium for installation in Ø 68mm ceiling cutout. Incl. 4-chip LED illuminant for maximum safety.

Technical data

Material:	Die-cast aluminum powder-coated
Illuminant:	LEDs
Luminous flux:	545 lm
Nominal voltage AC:	230V ±10% 50/60 Hz
Nominal voltage DC:	176 - 264 V
Nominal current AC:	33 mA
Nominal current DC:	25 mA

Apparent power:	7,6 VA
Effective power:	5,7 W
Inrush current:	8 A / 50 µs
Protection class:	II
Input terminals:	2.5mm ² feed through wiring
Temperature ta:	-15...+40 °C

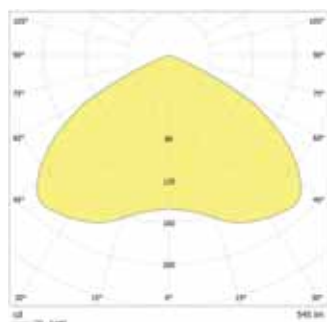

Minimum illumination 1.0 lx (middle of escape route), Maintenance factor 0.8

[m]	6.9	17.5
6.0	6.9	17.5
6.5	7.0	18.1
7.0	7.1	18.6
7.5	7.1	19.0
8.0	6.9	19.3
8.5	6.7	19.6
9.0	6.3	19.8
9.5	5.8	20.0
10.0	5.2	20.1

Minimum illumination 1.0 Lux (area illumination), Maintenance factor 0.8

[m]	4.9	14.2
6.0	4.9	14.2
6.5	5.1	14.7
7.0	5.0	14.9
7.5	4.9	16.2
8.0	4.7	16.3
8.5	4.7	16.8
9.0	4.6	17.5
9.5	4.5	17.7
10.0	4.3	16.6

Available colours Add colour code to the article no. e.g. 800 014 LXX

RAL 9016 (Traffic white): **L04** Special colour: **L99**

Articles

SN 9400-12 SHB LED J/SV round

Art. no. 809 441

Recessed ceiling mounting Light colour: 4000 K Protection category: IP20

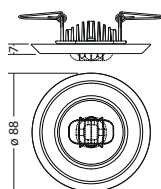

SN 9400-12 SHB LED J/SV square

Art. no. 809 445

Recessed ceiling mounting Light colour: 4000 K Protection category: IP20

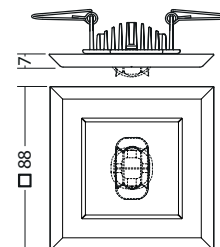
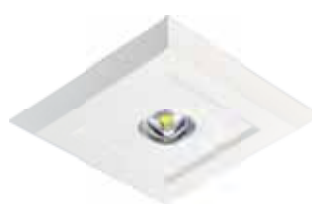

LED-Supply 230-3 J-SV SK II ext.

Art. no. 890 490

required

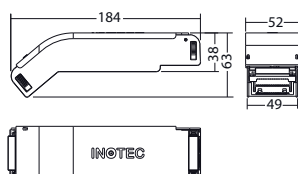



LED safety luminaire with optimised light distribution for the illumination of escape routes. Housing made of powder-coated aluminium for installation in Ø 68mm ceiling cutout. Incl. 4-chip LED illuminant for maximum safety.

Technical data

Material:	Die-cast aluminum powder-coated	Apparent power:	3,5 VA
Illuminant:	LEDs	Effective power:	2,6 W
Luminous flux:	139 lm	Inrush current:	8 A / 50 µs
Nominal voltage AC:	230V ±10% 50/60 Hz	Protection class:	II
Nominal voltage DC:	176 - 264 V	Input terminals:	2.5mm ² feed through wiring
Nominal current AC:	15 mA	Temperature ta:	-15...+40 °C
Nominal current DC:	12 mA		

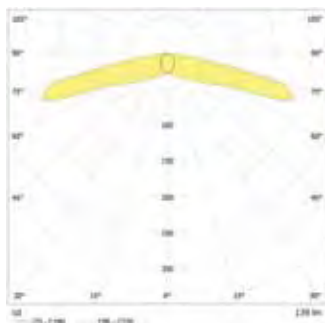

Minimum illumination 1.0 lx (middle of escape route), Maintenance factor 0.8

Height [m]	2.5	3.0	3.5	4.0	4.5
Beam diameter [m]	6.8	5.3	4.8	3.8	3.0
Beam diameter [m]	17.0	18.1	17.9	17.3	14.3
Beam diameter [m]	5.3	5.4	5.4	5.3	5.0
Beam diameter [m]	1.9	1.8	1.6	1.3	0.9

Available colours Add colour code to the article no. e.g. 800 014 LXX

RAL 9016 (Traffic white): **L04** Special colour: **L99**

Articles

SN 9400-03 ALB LED J/SV round

Art. no. 809 442

Recessed ceiling mounting Light colour: 4000 K Protection category: IP20

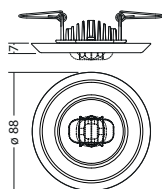

SN 9400-03 ALB LED J/SV square

Art. no. 809 446

Recessed ceiling mounting Light colour: 4000 K Protection category: IP20

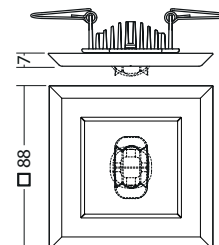

LED-Supply 230-3 J-SV SK II ext.

Art. no. 890 490

required

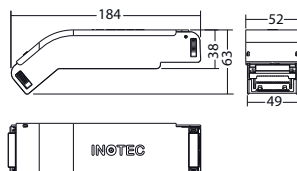



LED safety luminaire with optimised light distribution for the illumination of escape routes with high mounting heights. Also suitable for illumination of firefighting and fire alarm systems as well as first aid stations with 5 lx vertical illuminance. Housing made of powder-coated aluminium for installation in Ø 68mm ceiling cutout. Incl. 4-chip LED illuminant for maximum safety.



Technical data

Material:	Die-cast aluminum powder-coated	Apparent power:	4,4 VA
Illuminant:	LEDs	Effective power:	3,6 W
Luminous flux:	287 lm	Inrush current:	8 A / 50 µs
Nominal voltage AC:	230V ±10% 50/60 Hz	Protection class:	II
Nominal voltage DC:	176 - 264 V	Input terminals:	2.5mm ² feed through wiring
Nominal current AC:	19 mA	Temperature ta:	-15...+40 °C
Nominal current DC:	16 mA		

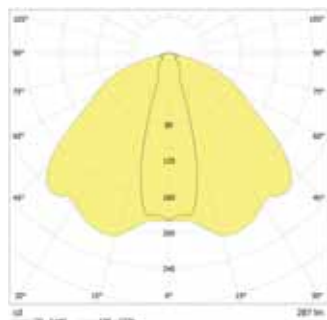

Minimum illumination 1.0 lx (middle of escape route), Maintenance factor 0.8

Distance (m)	1.0 lx	1.5 lx	2.0 lx	3.0 lx	4.0 lx
5.0	6.5	16.0	5.8	1.9	
6.0	7.0	17.2	5.2	2.1	
7.0	7.3	18.4	5.5	2.3	
8.0	7.3	19.5	5.8	2.4	
9.0	6.8	20.3	6.2	2.4	
10.0	6.0	20.7	6.5	2.4	
11.0	5.4	20.7	6.7	2.2	
12.0	4.2	20.0	6.8	0.7	

Available colours Add colour code to the article no. e.g. 800 014 LXX

RAL 9016 (Traffic white): L04 Special colour: L99

Articles

SN 9400-06 AHB LED J/SV round

Art. no. 809 443

Recessed ceiling mounting

Light colour: 4000 K

Protection category: IP20

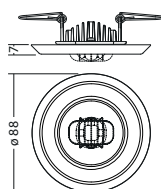

SN 9400-06 AHB LED J/SV square

Art. no. 809 447

Recessed ceiling mounting

Light colour: 4000 K

Protection category: IP20

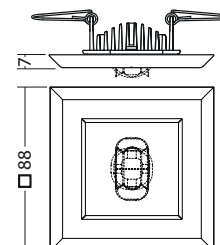

LED-Supply 230-3 J-SV SK II ext.

Art. no. 890 490

required

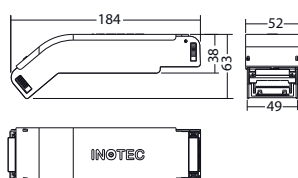

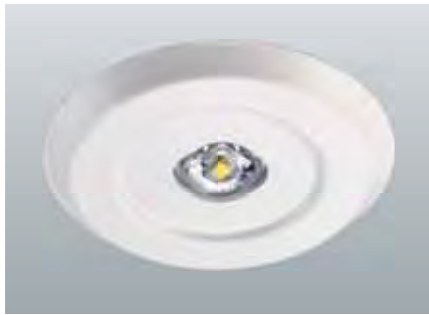

LED safety luminaire with optimised light distribution for the illumination of small areas such as lavatories or electrical operating rooms with a luminaire. Housing made of powder-coated aluminium for installation in Ø 68mm ceiling cutout. Incl. 4-chip LED illuminant for maximum safety.

Technical data

Material:	Die-cast aluminum powder-coated	Apparent power:	3,5 VA
Illuminant:	LEDs	Effective power:	2,6 W
Luminous flux:	146 lm	Inrush current:	8 A / 50 µs
Nominal voltage AC:	230V ±10% 50/60 Hz	Protection class:	II
Nominal voltage DC:	176 - 264 V	Input terminals:	2.5mm ² feed through wiring
Nominal current AC:	15 mA	Temperature ta:	-15...+40 °C
Nominal current DC:	12 mA		

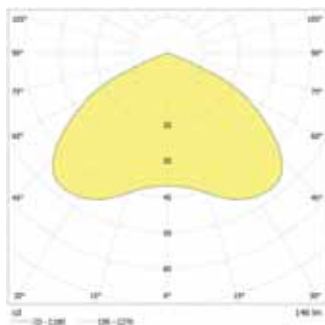

Minimum illumination 1.0 lx (middle of escape route), Maintenance factor 0.8

[m]	2.5	3.3	8.2
2.5	3.0	3.5	8.8
3.0	3.5	3.6	9.4
3.5	4.0	3.5	9.8
4.0	4.5	3.2	10.0
4.5	5.0	2.7	10.1

Minimum illumination 1.0 Lux (area illumination), Maintenance factor 0.8

[m]	2.5	2.2	6.8
2.5	3.0	2.3	7.4
3.0	3.5	2.5	8.0
3.5	4.0	2.6	8.4
4.0	4.5	2.5	8.6
4.5	5.0	2.4	8.2

Available colours Add colour code to the article no. e.g. 800 014 LXX

RAL 9016 (Traffic white): **L04** Special colour: **L99**

Articles

SN 9400-03 SLB LED J/SV round

Art. no. 809 448

Recessed ceiling mounting Light colour: 4000 K Protection category: IP20

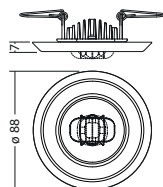

SN 9400-03 SLB LED J/SV square

Art. no. 809 450

Recessed ceiling mounting Light colour: 4000 K Protection category: IP20

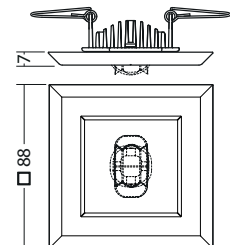

LED-Supply 230-3 J-SV SK II ext.

Art. no. 890 490

required

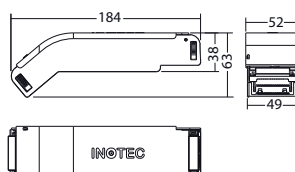

Optional side cable entry for surface-mounted installations

The SN 8400 emergency luminaires are available in round and square versions. Therefore, they can be harmoniously integrated into the existing architecture.

The housing offers the possibility of side cable entry without additional accessories. The side entries are not visible at standard surface mounting, but can be opened easily if needed.





LED safety luminaire with optimised light distribution for the illumination of spaces. Housing made of powder-coated aluminium for ceiling mounting with optional cable entry at the side. Incl. 4-chip LED illuminant for maximum safety.

Technical data

Material:	Die-cast aluminum powder-coated	Apparent power:	7,6 VA
Illuminant:	LEDs	Effective power:	5,7 W
Luminous flux:	513 lm	Inrush current:	8 A / 50 µs
Nominal voltage AC:	230V ±10% 50/60 Hz	Protection class:	I
Nominal voltage DC:	176 - 264 V	Input terminals:	2.5mm ² feed through wiring
Nominal current AC:	33 mA	Temperature ta:	-15...+40 °C
Nominal current DC:	25 mA		

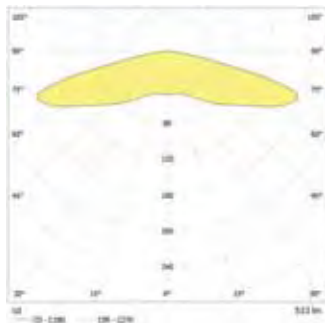

Minimum illumination 1.0 lx (middle of escape route), Maintenance factor 0.8

Distance [m]	Beam diameter [mm]	Beam diameter [mm]
2.5	6.2	16.0
3.0	6.3	17.0
3.5	6.1	17.6
4.0	5.7	17.8
4.5	5.3	17.7
5.0	4.7	17.3
5.5	3.5	16.4
6.0	1.4	15.6

Minimum illumination 1.0 Lux (area illumination), Maintenance factor 0.8

Distance [m]	Beam diameter [mm]	Beam diameter [mm]
2.5	4.5	12.6
3.0	4.9	14.0
3.5	5.0	14.9
4.0	4.6	15.5
4.5	4.1	15.1
5.0	3.9	14.5
5.5	3.7	14.3
6.0	3.5	14.1

Available colours Add colour code to the article no. e.g. 800 014 LXX

RAL 9016 (Traffic white): **L04** Special colour: **L99**

Articles

SN 8400-12 SLB LED J/SV round

Art. no. 808 200

Ceiling mounting Light colour: 4000 K Protection category: IP40

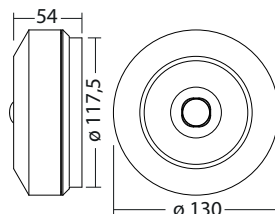

SN 8400-12 SLB LED J/SV square

Art. no. 808 208

Ceiling mounting Light colour: 4000 K Protection category: IP40

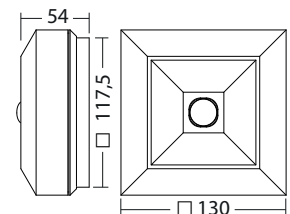

Chain suspension SN 8400 rd, RAL 9016

Art. no. 890 871 L04

optional accessories

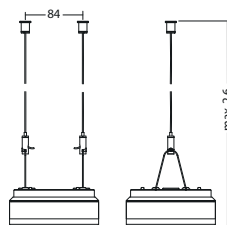

Chain suspension SN 8400 sq, RAL 9016

Art. no. 890 872 L04

optional accessories

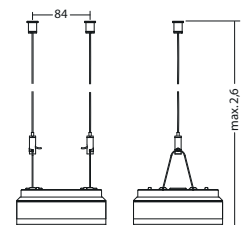



LED safety luminaire with optimised light distribution for the illumination of spaces with high mounting heights. Housing made of powder-coated aluminium for ceiling mounting with optional cable entry at the side. Incl. 4-chip LED illuminant for maximum safety.

Technical data

Material:	Die-cast aluminum powder-coated
Illuminant:	LEDs
Luminous flux:	543 lm
Nominal voltage AC:	230V ±10% 50/60 Hz
Nominal voltage DC:	176 - 264 V
Nominal current AC:	33 mA
Nominal current DC:	25 mA

Apparent power:	7,6 VA
Effective power:	5,7 W
Inrush current:	8 A / 50 µs
Protection class:	I
Input terminals:	2.5mm ² feed through wiring
Temperature ta:	-15...+40 °C

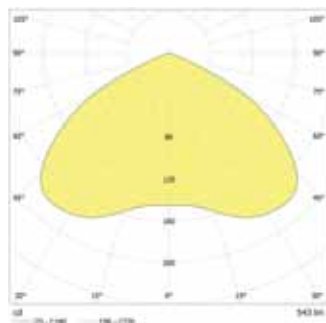

Minimum illumination 1.0 lx (middle of escape route), Maintenance factor 0.8

Height [m]	1.0 lx	0.8 lx
6.0	6.9	17.3
6.5	7.0	17.9
7.0	7.0	18.3
7.5	6.9	18.8
8.0	6.8	19.1
8.5	6.5	19.4
9.0	6.2	19.6
9.5	5.7	19.7
10.0	5.0	19.8

Minimum illumination 1.0 Lux (area illumination), Maintenance factor 0.8

Height [m]	1.0 Lux	0.8 Lux
6.0	4.9	14.2
6.5	5.1	14.7
7.0	5.0	14.9
7.5	4.9	16.2
8.0	4.7	16.3
8.5	4.7	16.8
9.0	4.6	17.5
9.5	4.5	17.7
10.0	4.3	16.6

Available colours Add colour code to the article no. e.g. 800 014 LXX

RAL 9016 (Traffic white): **L04** Special colour: **L99**

Articles

SN 8400-12 SHB LED J/SV round

Art. no. 808 201

Ceiling mounting Light colour: 4000 K Protection category: IP40

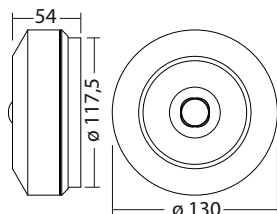

SN 8400-12 SHB LED J/SV square

Art. no. 808 209

Ceiling mounting Light colour: 4000 K Protection category: IP40

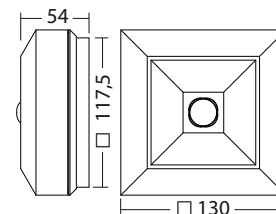

Chain suspension SN 8400 rd, RAL 9016

Art. no. 890 871 L04

optional accessories

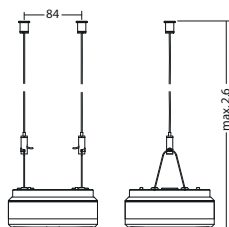

Chain suspension SN 8400 sq, RAL 9016

Art. no. 890 872 L04

optional accessories

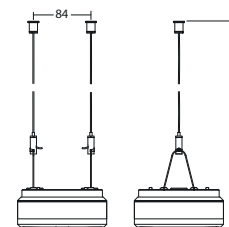



LED safety luminaire with optimised light distribution for the illumination of escape routes. Housing made of powder-coated aluminium for ceiling mounting with optional cable entry at the side. Incl. 4-chip LED illuminant for maximum safety.

Technical data

Material:	Die-cast aluminum powder-coated	Apparent power:	3,5 VA
Illuminant:	LEDs	Effective power:	2,6 W
Luminous flux:	133 lm	Inrush current:	8 A / 50 µs
Nominal voltage AC:	230V ±10% 50/60 Hz	Protection class:	I
Nominal voltage DC:	176 - 264 V	Input terminals:	2.5mm ² feed through wiring
Nominal current AC:	15 mA	Temperature ta:	-15...+40 °C
Nominal current DC:	12 mA		

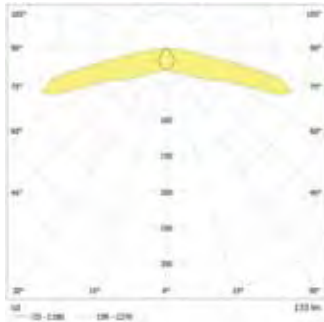

Minimum illumination 1.0 lx (middle of escape route), Maintenance factor 0.8

[m]	2.5	3.0	3.5	4.0	4.5
1.0	6.7	5.3	4.9	3.9	3.1
1.5	16.9	18.1	17.8	16.6	14.4
2.0	4.7	5.1	5.5	5.6	5.5
2.5	1.9	2.0	1.8	1.5	1.1

Available colours Add colour code to the article no. e.g. 800 014 LXX

RAL 9016 (Traffic white): **L04** Special colour: **L99**

Articles

SN 8400-03 ALB LED J/SV round

Art. no. 808 202

Ceiling mounting Light colour: 4000 K Protection category: IP40

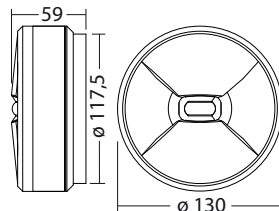

SN 8400-03 ALB LED J/SV square

Art. no. 808 210

Ceiling mounting Light colour: 4000 K Protection category: IP40

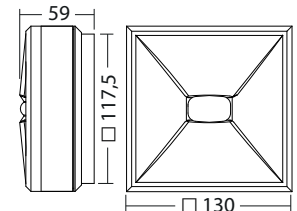

Chain suspension SN 8400 rd, RAL 9016

Art. no. 890 871 L04

optional accessories

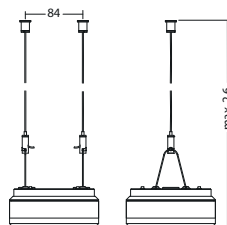

Chain suspension SN 8400 sq, RAL 9016

Art. no. 890 872 L04

optional accessories

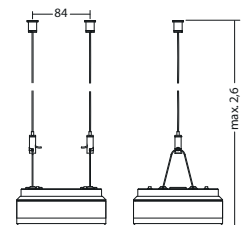



LED safety luminaire with optimised light distribution for the illumination of escape routes with high mounting heights. Also suitable for illumination of firefighting and fire alarm systems as well as first aid stations with 5 lx vertical illuminance. Housing made of powder-coated aluminium for ceiling mounting with optional cable entry at the side. Incl. 4-chip LED illuminant for maximum safety.



Technical data

Material:	Die-cast aluminum powder-coated	Apparent power:	4,4 VA
Illuminant:	LEDs	Effective power:	3,6 W
Luminous flux:	275 lm	Inrush current:	8 A / 50 µs
Nominal voltage AC:	230V ±10% 50/60 Hz	Protection class:	I
Nominal voltage DC:	176 - 264 V	Input terminals:	2.5mm ² feed through wiring
Nominal current AC:	19 mA	Temperature ta:	-15...+40 °C
Nominal current DC:	16 mA		

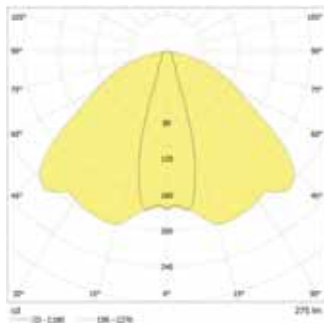

Minimum illumination 1.0 lx (middle of escape route), Maintenance factor 0.8

Distance (m)	1.0 lx	1.5 lx	2.0 lx	3.0 lx	4.0 lx
5.0	6.6	16.0	5.0	1.9	
6.0	7.2	17.4	4.9	2.1	
7.0	7.5	18.7	5.4	2.3	
8.0	7.4	19.9	5.7	2.4	
9.0	6.6	20.7	6.2	2.4	
10.0	5.9	21.1	6.5	2.3	
11.0	4.9	20.9	6.7	2.1	

Available colours Add colour code to the article no. e.g. 800 014 LXX

RAL 9016 (Traffic white): **L04** Special colour: **L99**

Articles

SN 8400-06 AHB LED J/SV round

Art. no. 808 203

Ceiling mounting Light colour: 4000 K Protection category: IP40

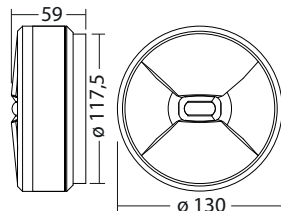

SN 8400-06 AHB LED J/SV square

Art. no. 808 211

Ceiling mounting Light colour: 4000 K Protection category: IP40

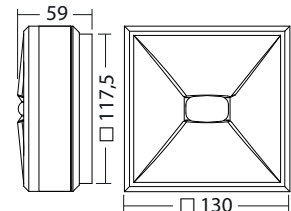

Chain suspension SN 8400 rd, RAL 9016

Art. no. 890 871 L04

optional accessories

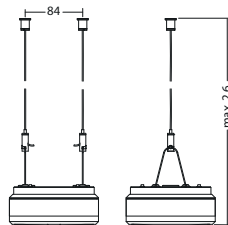

Chain suspension SN 8400 sq, RAL 9016

Art. no. 890 872 L04

optional accessories

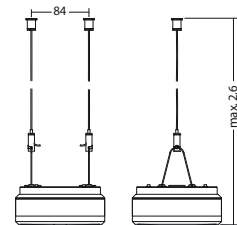



LED safety luminaire with optimised light distribution for the illumination of small areas such as lavatories or electrical operating rooms with a luminaire. Housing made of powder-coated aluminium for ceiling mounting with optional cable entry at the side. Incl. 4-chip LED illuminant for maximum safety.

Technical data

Material:	Die-cast aluminum powder-coated	Apparent power:	3,5 VA
Illuminant:	LEDs	Effective power:	2,6 W
Luminous flux:	145 lm	Inrush current:	8 A / 50 µs
Nominal voltage AC:	230V ±10% 50/60 Hz	Protection class:	I
Nominal voltage DC:	176 - 264 V	Input terminals:	2.5mm ² feed through wiring
Nominal current AC:	15 mA	Temperature ta:	-15...+40 °C
Nominal current DC:	12 mA		

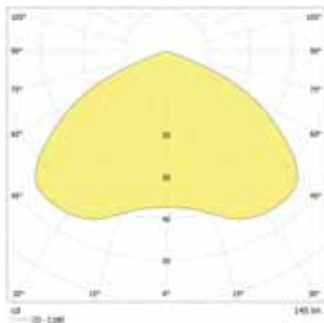

Minimum illumination 1.0 lx (middle of escape route), Maintenance factor 0.8

[m]	2.5	3.3	8.2
2.5	3.0	3.5	8.8
3.0	3.5	9.3	
3.5	3.4	9.7	
4.0	3.1	9.9	
4.5	2.6	10.0	

Minimum illumination 1.0 Lux (area illumination), Maintenance factor 0.8

[m]	2.5	2.2	6.8
2.5	2.3	7.4	
3.0	2.5	8.0	
3.5	2.6	8.4	
4.0	2.5	8.6	
4.5	2.4	8.2	

Available colours Add colour code to the article no. e.g. 800 014 LXX

RAL 9016 (Traffic white): **L04** Special colour: **L99**

Articles

SN 8400-03 SLB LED J/SV round

Art. no. 808 216

Ceiling mounting Light colour: 4000 K Protection category: IP40

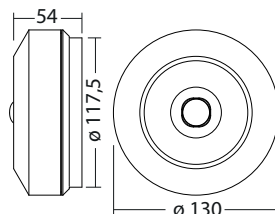

SN 8400-03 SLB LED J/SV square

Art. no. 808 220

Ceiling mounting Light colour: 4000 K Protection category: IP40

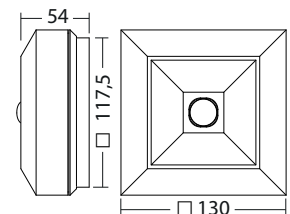

Chain suspension SN 8400 rd, RAL 9016

Art. no. 890 871 L04

optional accessories

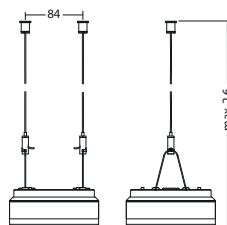

Chain suspension SN 8400 sq, RAL 9016

Art. no. 890 872 L04

optional accessories

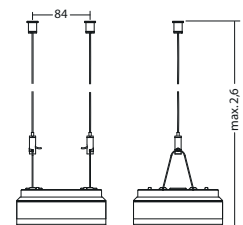



Performance-optimised illumination of large areas

The SN 8500-08 SHB is ideal for illuminating large areas with an illuminance of one lux.

Secondary optics with rotationally symmetrical light distribution enable effective and homogeneous illumination.

The highly efficient LED illuminant with a luminous flux of more than 160lm/W ensures significant luminaire spacing between luminaires for large mounting heights.

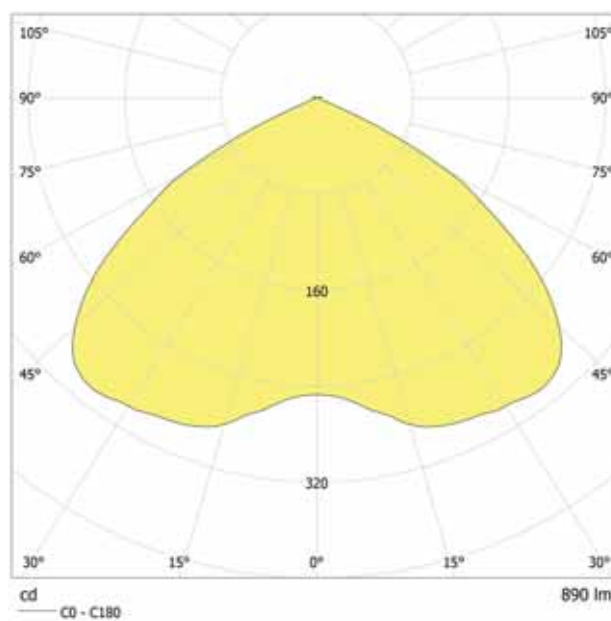



The robust powder-coated die-cast aluminium housing of the SN 8500 is ideally suited for use in industry. The luminaire is protected against the ingress of water and dust by the high protection degree of IP65.

In addition to the cable entries from behind, the housing also offers the option of inserting cable glands laterally into the housing. For this purpose, two pre-embossed openings can simply be removed on each of the three sides.

Optional accessories allow the luminaire to be mounted flexibly. The SN 8500 can be suspended on chains, mounted on the wall with a lockable wall bracket or installed in the ceiling with a mounting frame.



Safety lighting for workplaces with special hazards

Due to the increased risk of accidents in the event of a power failure, EN 1838 requires an increased lighting level for workplaces with special hazards.

In these areas, the illuminance in emergency operation shall be at least 10 % of the illuminance required for the task. However, at no point shall the illuminance drop below 15 lx.



Tip for installation

For high ceilings, e.g. in industrial halls, the SN 8500 can be suspended with optional chain hooks above the area that needs to be illuminated.

Examples of work areas with special hazards according to ASR A3.4/7:

laboratories

if it is necessary for employees to stop or interrupt an ongoing test in order to prevent acute danger to employees and third parties. Such serious hazards may include explosions or fires and the release of pathogens or of toxic, very toxic or radioactive substances in hazardous quantities

workplaces

which must be kept dark for technical reasons

electrical operating rooms and rooms for technical installations

which must be entered in the event of failure of artificial lighting

the immediate area of long-lasting work equipment

with moving parts which could not be protected and which can cause accident hazards, e.g. facing lathes, as far as additional accident hazards are caused by light failure

Control devices for permanently monitored systems

e.g. control rooms and control stations for power plants, chemical and metallurgical plants as well as workplaces at locking and control equipment which must be operated during operation or in the event of malfunctions to avoid the risk of accidents in order to interrupt or terminate production processes safely

workstations near hot baths or casting pits

which cannot be secured by railings or barriers for technical production reasons

areas around working pits

which cannot be covered for operational reasons.

workstations on construction sites

Case study

Work area:	Laboratory
Mounting:	ceiling mounting: (4m height)
Work surface:	4m x 1m
Required illuminance:	E_m : 75lx (10% of general lighting)
	E_{min} : 15lx
Uniformity:	1:10 (> 0,1)
Luminaire:	1 x SN 8500-25

In this example, a SN 8500-25 luminaire can be used to achieve the required average illuminance of 75lx within a 4m x1m working area. The uniformity (E_{min}/E_{max}) is 0.3.

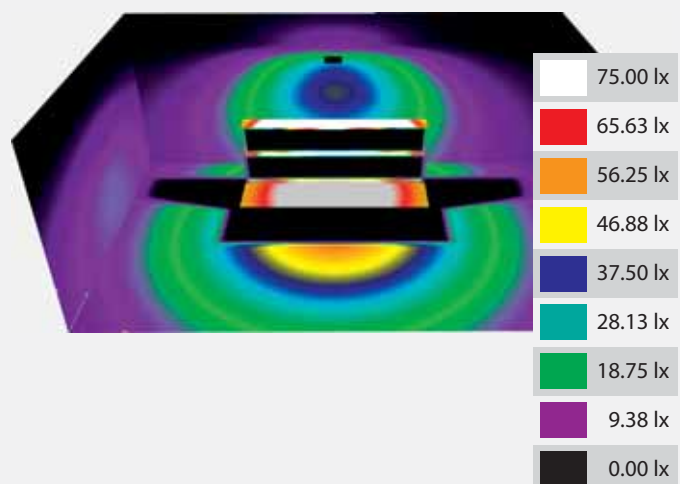



Lighting requirements for swimming pools

The KOK Directive on the Construction of Swimming Pools (2013) requires for swimming pools with a water depth of 1.35 metres or more, to have an illuminance of up to 15 lux on the water surface.

If there is a risk of accidents due to failure of the general lighting, the 107-001 "Operation of baths" rule of the German statutory accident insurance (DGUV) requires safety lighting with an illuminance of one percent of the general lighting, but at least one lux.

Mounting

The KOK guideline recommends that luminaires should not be installed above the water surface, but parallel to the swimming pool. This also makes maintenance much easier. The optionally available lockable mounting bracket of the SN 8500 allows precise illumination of the water surface. This means that even areas that are difficult to illuminate can be illuminated in accordance with standards.

Housing

The SN 8500 luminaire series consists of high-quality, corrosion-resistant die-cast aluminium. The powder-coated housing is also highly resistant to chlorine. The IP65 degree of protection makes these luminaires ideal for use in swimming pools.



Case study

Project:	swimming pool
Mounting:	ceiling mounting (7m height)
Pool size:	26m x 20m
Required illuminance on the water surface:	E _{min} : 15lx
Luminaire:	10 x SN 8500-25

In this project example ten SN 8500-25 are used to illuminate the water surface with at least 15lx. The inclination can be selected with the optional mounting bracket so that the luminaires do not have to be mounted above the water surface.

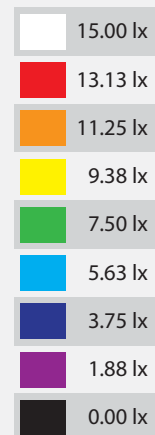
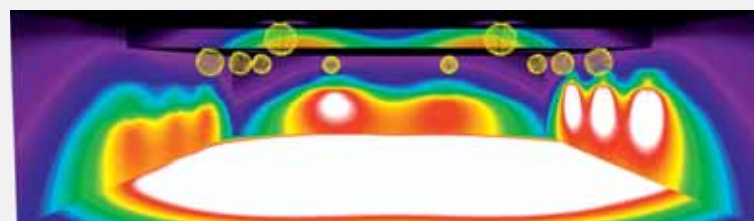
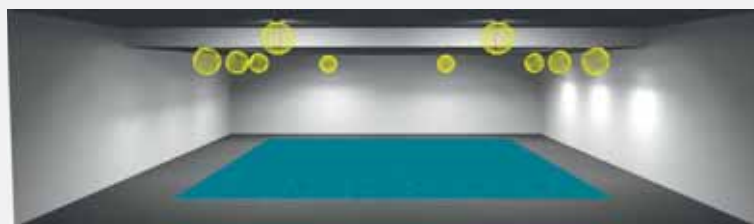
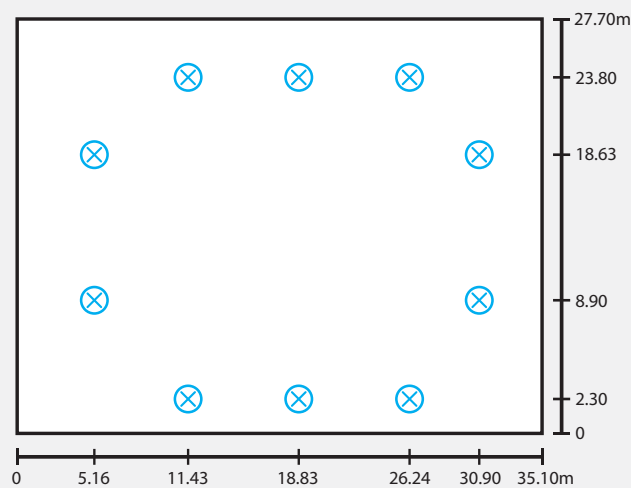



Safety lighting for sports facilities in accordance with EN 12193

If a power failure occurs during a sporting event, it can quickly become dangerous for participants due to the lack of lighting. EN 12193 therefore requires a higher level of safety lighting for selected sporting categories than that specified in EN 1838. Depending on the type of sport, a certain percentage of the specified mean illuminance must be achieved for a period of between 30 and 120 seconds. At the end of this period, the requirements of EN 1838 apply.

The average illuminance levels depend on the competition level and the sports practised. The competition level is divided into different lighting classes.

Competitive level	Illumination classes		
	I	II	III
International / National	*		
Regional	*	*	
Local	*	*	*
Training		*	*
School sports / leisure sports			*

EN 12193 defines the following values for the various lighting classes:

Indoor facilities				
Sports	Duration	Class I	Class II	Class III
		E_m	E_m	E_m
Swimming	30s	25 lx	15 lx	10 lx
Gymnastics	30s	25 lx	15 lx	10 lx
Horse Riding	120s	25 lx	15 lx	10 lx
Speed skating	30s	25 lx	15 lx	10 lx
Cycling	60s	75 lx	50 lx	20 lx

* In contrast to the minimum illuminance usually used in emergency lighting, this is a medium illuminance level

** The stated values are maintenance values.

*** Uniformity (E_{min}/E_m) for emergency operation during the specified period is not specified in EN 12193. In order to ensure sufficient visual conditions, we recommend a uniformity of 50% of the value prescribed for the competition.

Impact resistant acc. to VDE 0710-13

The ball-proof and impact-resistant housing (IK10) can also be easily integrated into suspended hall ceilings with an installation frame.



Case study

Type of sport:	Gymnastics (lighting class I)
Mounting:	Ceiling mounting (12m height)
Playing field	45m x 25m
Required illuminance in emergency mode for the first 30 seconds:	Em: 25lx g: 0,35 (Emin/Em)
Required illuminance in emergency mode after 30 seconds:	Emin: 1lx g: 0,025 (Emin/Emax)
Luminaire:	15 x SN 8500-25

In this example, 15 SN 8500-25 luminaires can be used to achieve the required average illuminance of 25lx on a 45m x 25m playing field. The uniformity (Emin/Em) is 0.6.

With INOTEC FUSION emergency lighting units, it is also possible to switch off individual luminaires after a defined time in DC mode. This significantly reduces the battery capacity.

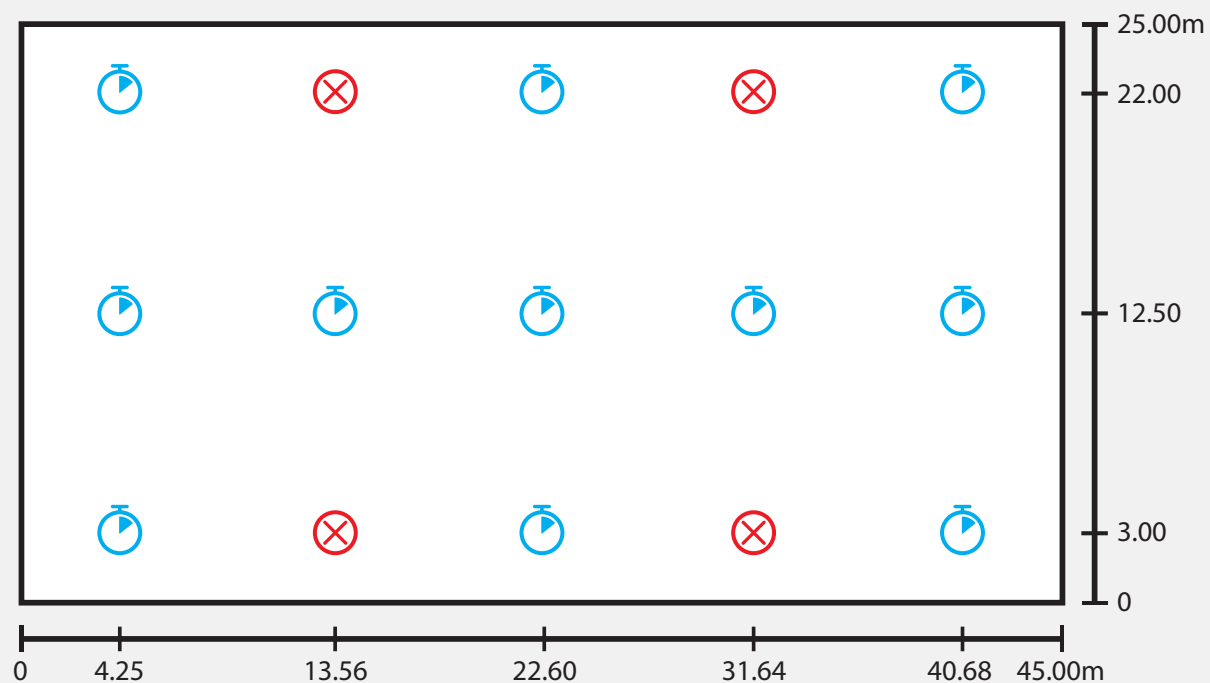

The corresponding luminaires are programmed in the controller or in the configurator.

This means that 11 emergency luminaires (blue) of the total of 15 luminaires can be switched off after 30 seconds. The four other luminaires (red) are sufficient to illuminate the entire sports hall with at least 1 lx.

230V

SN 8500-25 Downlights

J/SV

For connection to JOKER-central battery systems

INOTEC
Sicherheitstechnik GmbH

Downlight for enhanced lighting requirements. For illuminating workplaces with special risks, swimming pools or sports facilities. Robust housing made of die-cast aluminium with optional lateral cable gland.

**Technical data**

Material:	Die-cast aluminum	Apparent power:	30,9 VA
Illuminant:	LEDs	Effective power:	29,8 W
Luminous flux:	3401 lm	inrush current:	11 A / 264 μs
Nominal voltage AC:	230V ±10% 50/60 Hz	Protection class:	I
Nominal voltage DC:	176 - 264 V	Input terminals:	2.5mm ² feed through wiring
Nominal current AC:	134 mA	Temperature ta:	-15...+40 °C
Nominal current DC:	135 mA	Impact resistance:	IK10

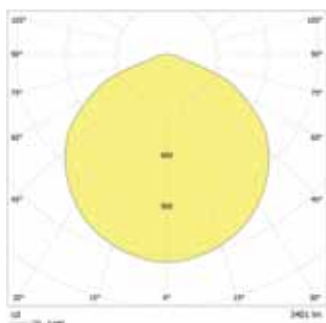

Available colours Add colour code to the article no. e.g. 800 014 LXX

RAL 9006 (White aluminium): **L10** ■ Special colour: **L99** ■

Articles**SN 8500-25 LED J/SV**

Art. no. 808 226

Ceiling mounting Light colour: 4000 K Protection category: IP65

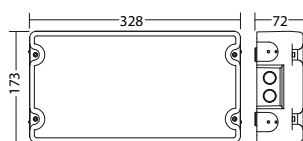
**Recessed ceiling frame SN 8500, RAL 9006**

Art. no. 890 401 L10

optional accessories

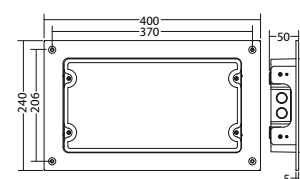
**Wall bracket SN 8500, RAL 9006**

Art. no. 890 402 L10

optional accessories

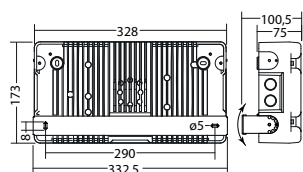
**Ringbolts for SN 8500/24xx**

Art. no. 890 403

optional accessories

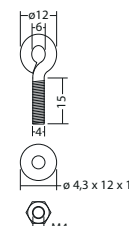



IK10



Downlight for enhanced lighting requirements. For illuminating large areas with high mounting heights. Robust housing made of die-cast aluminium with optional lateral cable gland.

Technical data

Material:	Die-cast aluminium
Illuminant:	LEDs
Luminous flux:	890 lm
Nominal voltage AC:	230V ±10% 50/60 Hz
Nominal voltage DC:	176 - 264 V
Nominal current AC:	54 mA
Nominal current DC:	49 mA

Apparent power:	12,5 VA
Effective power:	10,9 W
Inrush current:	8 A / 50 µs
Protection class:	I
Input terminals:	2.5mm ² feed through wiring
Temperature ta:	-15...+40 °C
Impact resistance:	IK10

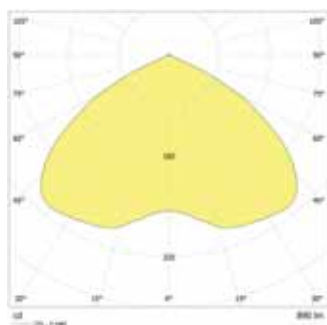

Minimum illumination 1.0 lx (middle of escape route), Maintenance factor 0.8

[m]	3.0	5.6	12.4
4.0	6.7	15.3	
5.0	7.4	17.7	
6.0	8.0	19.5	
7.0	8.5	21.0	
8.0	8.8	22.2	
9.0	8.9	23.2	
10.0	8.7	24.2	
11.0	8.3	24.8	
12.0	7.5	25.1	
13.0	6.5	25.1	
14.0	4.3	24.8	

Minimum illumination 1.0 Lux (area illumination), Maintenance factor 0.8

[m]	4.0	4.9	11.7
6.0	5.7	15.7	
8.0	6.1	18.6	
10.0	6.1	20.8	
12.0	5.8	22.5	
14.0	4.4	23.6	
16.0	3.5	20.2	
18.0	3.5	17.8	
20.0	3.5	16.5	
22.0	3.3	15.4	
24.0	3.0	12.5	

Available colours Add colour code to the article no. e.g. 800 014 LXX

RAL 9006 (White aluminium): **L10** ■ Special colour: **L99** ■

Articles

SN 8500-08 SHB LED J/SV

Art. no. 808 224

Ceiling mounting Light colour: 4000 K Protection category: IP65

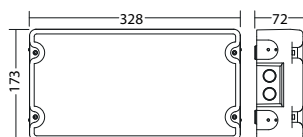

Recessed ceiling frame SN 8500, RAL 9006

Art. no. 890 401 L10

optional accessories

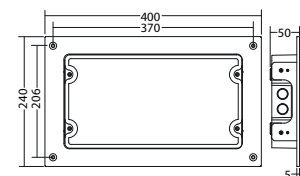

Wall bracket SN 8500, RAL 9006

Art. no. 890 402 L10

optional accessories

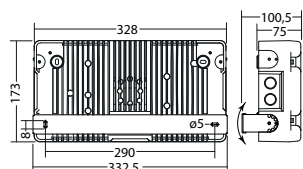

Ringbolts for SN 8500/24xx

Art. no. 890 403

optional accessories

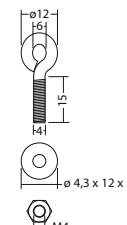



Downlight for enhanced lighting requirements. For illuminating workplaces with special risks, swimming pools or sports facilities. Robust housing made of die-cast aluminium with optional lateral cable gland.



Technical data

Material:	Die-cast aluminum
Illuminant:	LEDs
Luminous flux:	1652 lm
Nominal voltage AC:	230V ±10% 50/60 Hz
Nominal voltage DC:	176 - 264 V
Nominal current AC:	84 mA
Nominal current DC:	80 mA

Apparent power:	19,4 VA
Effective power:	17,9 W
inrush current:	11 A / 264 µs
Protection class:	I
Input terminals:	2.5mm ² feed through wiring
Temperature ta:	-15...+40 °C
Impact resistance:	IK10



Available colours Add colour code to the article no. e.g. 800 014 LXX

RAL 9006 (White aluminium): **L10** ■ Special colour: **L99** ■

Articles

SN 8500-12 LED J/SV

Art. no. 808 225

Ceiling mounting Light colour: 4000 K Protection category: IP65

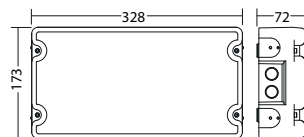

Recessed ceiling frame SN 8500, RAL 9006

Art. no. 890 401 L10

optional accessories

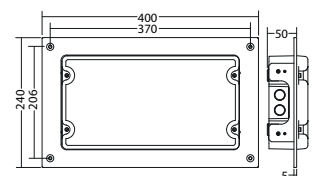

Wall bracket SN 8500, RAL 9006

Art. no. 890 402 L10

optional accessories

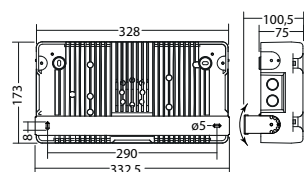

Ringbolts for SN 8500/24xx

Art. no. 890 403

optional accessories

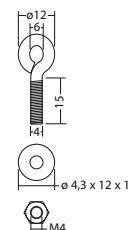





Downlight for enhanced lighting requirements. For illuminating workplaces with special risks, swimming pools or sports facilities. Robust housing made of die-cast aluminium with optional lateral cable gland. With timer function in DC operation to reduce the battery capacity. Ideally suited according to EN 12193.



Technical data

Material:	Die-cast aluminum	Apparent power:	30,9 VA
Illuminant:	LEDs	Effective power:	29,8 W
Luminous flux:	3401 lm	inrush current:	15 A / 82 µs
Nominal voltage AC:	230V ±10% 50/60 Hz	Protection class:	I
Nominal voltage DC:	176 - 264 V	Input terminals:	2.5mm ² feed through wiring
Nominal current AC:	134 mA	Temperature ta:	-15...+40 °C
Nominal current DC:	135 mA	Impact resistance:	IK10

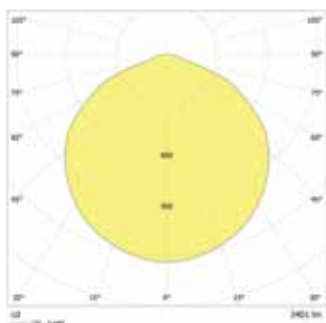

Available colours Add colour code to the article no. e.g. 800 014 LXX

RAL 9006 (White aluminium): **L10** ■ Special colour: **L99** ■

Articles

SN 8500-25 LED J/SV

Art. no. 808 227

Ceiling mounting Light colour: 4000 K Protection category: IP65

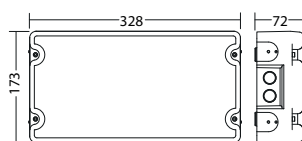

Recessed ceiling frame SN 8500, RAL 9006

Art. no. 890 401 L10

optional accessories

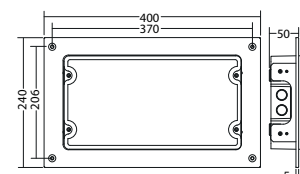

Wall bracket SN 8500, RAL 9006

Art. no. 890 402 L10

optional accessories

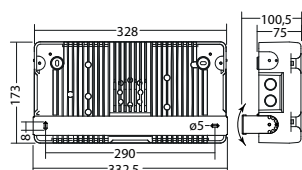

Ringbolts for SN 8500/24xx

Art. no. 890 403

optional accessories

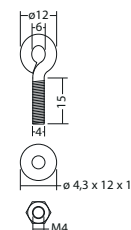

Elegant aluminium surface-mounted downlight for indoor and outdoor use

Thanks to its modern design and high IP65 protection rating, the new SN 8040 surface-mounted spotlight is suitable for both representative and functional areas. As with all new INOTEC products, we apply state-of-the-art lighting technology to this luminaire as well. You can choose between the new INOTEC TES illuminant and a 4x1W LED illuminant. The housing, made of high-quality aluminium, not only impresses with its visual appearance, but also offers sufficient connection space for simple and quick installation.

By using high-quality powder coatings, INOTEC is able to adapt the SN 8040 colour to the architecture. This allows all RAL colours to be realised in a premium structured finish.

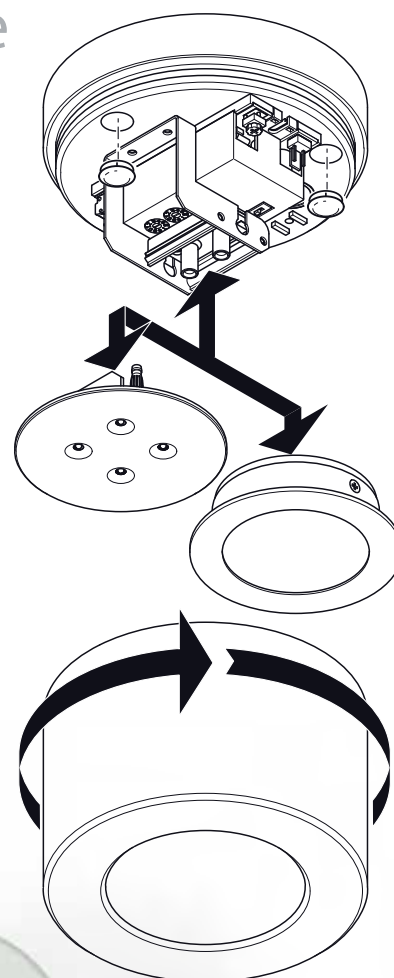



Elegant high-quality LED downlight ideal for area or escape route illumination. Perfect for combined usage of safety and general lighting. Possible adaption to the light colour of the general lighting by Translucent-Emitting-Surface (TES) technology. Powder-coated aluminium housing for ceiling mounting with high protection category and without any visible screws.

Technical data

Material:	Aluminium powder-coated	Nominal current DC:	32 mA
Illuminant:	LEDs	Apparent power:	8,3 VA
Luminous flux:	261 lm	Inrush current:	8 A / 50 µs
Nominal voltage AC:	230V ±10% 50/60 Hz	Protection class:	I
Nominal voltage DC:	176 - 264 V	Input terminals:	2.5mm ² feed through wiring
Nominal current AC:	36 mA	Temperature ta:	-15...+40 °C

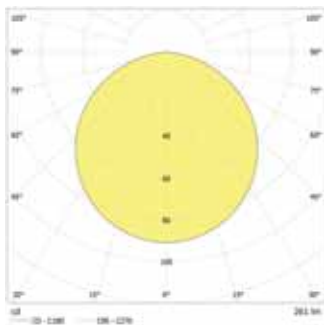

Minimum illumination 1.0 lx (middle of escape route), Maintenance factor 0.8

(m)	2.5	3.7	9.4
2.5	3.7	9.4	
3.0	3.8	10.1	
4.0	4.1	11.0	
5.0	4.1	11.6	
6.0	3.8	11.7	

Minimum illumination 1.0 Lux (area illumination), Maintenance factor 0.8

(m)	2.5	2.5	8.0
2.5	2.5	8.0	
3.0	2.7	8.6	
4.0	2.7	9.8	
5.0	2.7	10.6	
6.0	2.7	10.6	

Available colours Add colour code to the article no. e.g. 800 014 **LXX**

RAL 7015 (Slate grey): **L16** ■ RAL 9016 (Traffic white): **L04** □ Special colour: **L99** 🌈

Articles

SN 8040 LED J/SV

Art. no. 808 162

Ceiling mounting Light colour: 2700 K Protection category: IP65

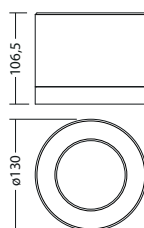

SN 8040 LED J/SV

Art. no. 808 165

Ceiling mounting Light colour: 3500 K Protection category: IP65

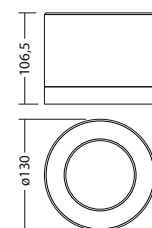

SN 8040 LED J/SV

Art. no. 808 168

Ceiling mounting Light colour: 4300 K Protection category: IP65

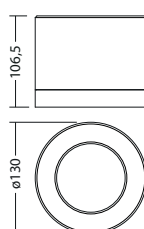





Elegant high-quality LED downlight ideal for area or escape route illumination. Powder-coated aluminium housing for ceiling mounting with high protection category and without any visible screws.

Technical data

Material:	Aluminium powder-coated	Nominal current DC:	32 mA
Illuminant:	LEDs	Apparent power:	8,3 VA
Luminous flux:	310 lm	Inrush current:	8 A / 50 µs
Nominal voltage AC:	230V ±10% 50/60 Hz	Protection class:	I
Nominal voltage DC:	176 - 264 V	Input terminals:	2.5mm ² feed through wiring
Nominal current AC:	36 mA	Temperature ta:	-15...+40 °C

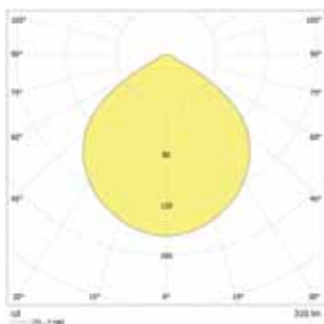

Minimum illumination 1.0 lx (middle of escape route), Maintenance factor 0.8

(m)	1	2
2.5	3.7	8.5
3.0	4.1	9.7
4.0	4.7	11.5
5.0	5.0	12.9
6.0	5.1	13.9
7.0	4.9	14.3
8.0	4.5	14.4
9.0	3.7	14.3
10.0	2.5	13.8

Minimum illumination 1.0 Lux (area illumination), Maintenance factor 0.8

(m)	1	2
2.5	2.7	6.4
3.0	3.1	7.3
4.0	3.6	9.0
5.0	3.7	10.6
6.0	3.7	11.8
7.0	3.6	12.4
8.0	3.4	12.8
9.0	3.1	12.6
10.0	2.6	12.4

Available colours Add colour code to the article no. e.g. 800 014 **LXX**

RAL 7015 (Slate grey): **L16** ■ RAL 9016 (Traffic white): **L04** □ Special colour: **L99** 🌈

Articles

SN 8040-41 LED J/SV

Art. no. 808 159

Ceiling mounting

Protection category: IP65

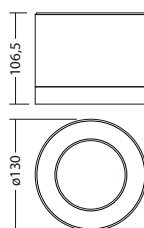

Universal surface-mounted spotlight with a flat design

Innovative lighting technology, easy installation and a flat design – these are the features that characterise the new safety luminaire SN 2040.

Different light sources, optimised for the widest possible range of structures, make the SN 2040 a universal safety luminaire. Whether for emergency routes, surface illumination, or mounting heights of up to 24m, the individual lamps ensure standards-compliant illumination.

With its rear cable entries, and optional knock-out side entries, this luminaire's construction also takes into account the trends and changes in electrical installation. Because of the great flexibility, people often resort to an exposed tube installation, even in the case of architecturally sophisticated buildings. The new SN 2040 offers all the advantages of surface mounting, while its flat design blends unobtrusively with the architecture.

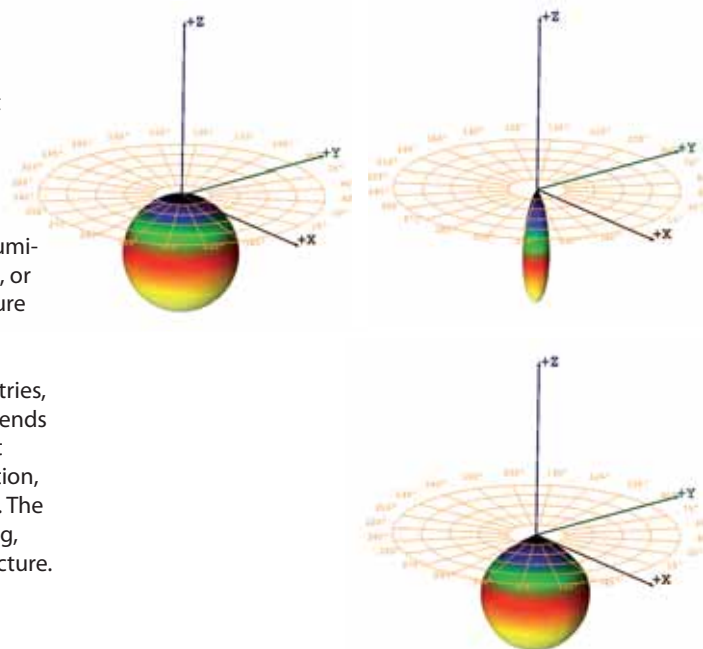



Functional LED downlight with a flat design ideal for area or escape route illumination. UV resistant, heat filament tested polycarbonate housing for ceiling mounting with optional side cable entry.

Technical data

Material:	Polycarbonate	Apparent power:	7,0 VA
Illuminant:	LEDs	Effective power:	5,5 W
Luminous flux:	310 lm	Inrush current:	6 A / 98 μ s
Nominal voltage AC:	230V \pm 10% 50/60 Hz	Protection class:	II
Nominal voltage DC:	176 - 264 V	Input terminals:	2.5mm ² feed through wiring
Nominal current AC:	31 mA	Temperature ta:	-15...+40 °C
Nominal current DC:	32 mA		

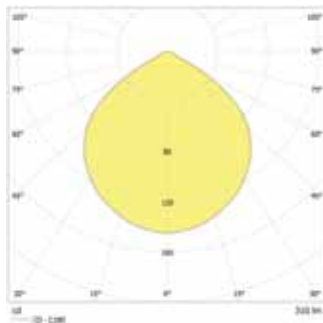

Minimum illumination 1.0 lx (middle of escape route), Maintenance factor 0.8

[m]	2.5	3.7	8.5
2.5	3.7	8.5	
3.0	4.1	9.7	
4.0	4.7	11.5	
5.0	5.0	12.9	
6.0	5.1	13.9	
7.0	4.9	14.3	
8.0	4.5	14.4	
9.0	3.7	14.3	
10.0	2.5	13.8	

Minimum illumination 1.0 Lux (area illumination), Maintenance factor 0.8

[m]	2.5	2.7	6.4
2.5	2.7	6.4	
3.0	3.1	7.3	
4.0	3.6	9.0	
5.0	3.7	10.6	
6.0	3.7	11.8	
7.0	3.6	12.4	
8.0	3.4	12.8	
9.0	3.1	12.6	
10.0	2.6	12.4	

Articles

SN 2040.1-41 LED J/SV

Art. no. 802 119 .1

Ceiling mounting

Protection category: IP40

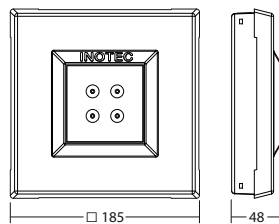





Functional LED downlight with a flat design for mounting height up to 32m, ideal for escape route illumination. UV resistant, heat filament tested polycarbonate housing for ceiling mounting with optional side cable entry.

Technical data

Material:	Polycarbonate	Apparent power:	7,0 VA
Illuminant:	LEDs	Effective power:	5,5 W
Luminous flux:	277 lm	Inrush current:	6 A / 98 μ s
Nominal voltage AC:	230V \pm 10% 50/60 Hz	Protection class:	II
Nominal voltage DC:	176 - 264 V	Input terminals:	2.5mm ² feed through wiring
Nominal current AC:	31 mA	Temperature ta:	-15...+40 °C
Nominal current DC:	32 mA		

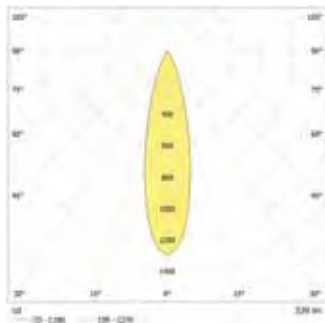

Minimum illumination 1.0 lx (middle of escape route), Maintenance factor 0.8

Distance [m]	Beam diameter [m]	Beam diameter [m]
11.0	4.6	11.1
12.0	4.7	11.5
14.0	4.9	12.5
16.0	5.0	13.2
18.0	5.0	13.7
20.0	5.0	14.0
22.0	4.9	14.2
24.0	4.6	14.3
26.0	4.2	14.3
28.0	3.7	14.1
30.0	2.9	14.1
32.0	0.9	13.6

Minimum illumination 1.0 Lux (area illumination), Maintenance factor 0.8

Distance [m]	Beam diameter [m]	Beam diameter [m]
11.0	4.6	11.1
12.0	4.7	11.5
14.0	4.9	12.5
16.0	5.0	13.2
18.0	5.0	13.7
20.0	5.0	14.0
22.0	4.9	14.2
24.0	4.6	14.3
26.0	4.2	14.3
28.0	3.7	14.1
30.0	2.9	14.1
32.0	0.9	13.6

Articles

SN 2040.1 T LED J/SV

Art. no. 802 125 .1

Ceiling mounting

Protection category: IP40

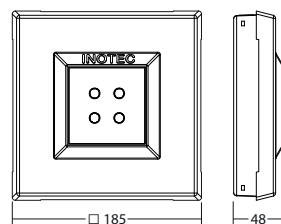



Ball-impact-proof and shock-resistant luminaires

The robust, ball-impact-proof and shock-resistant safety and exit sign luminaires are not only suitable for use in gyms and sports halls, but can also be used wherever luminaires are exposed to increased mechanical loads.

The luminaires are designed to pass the pendulum hammer test according to EN 50102 without any problems. All luminaires in this series comply with impact resistance class IK10. In addition, the luminaires passed a ball impact test in accordance with DIN VDE 0710-13. This eliminates the need for additional ball protection grids.

Despite these high requirements, these luminaires impress with their slim design and homogeneous illumination, which also makes them suitable for use in visually attractive buildings.

Advantages

- Easy installation
- Ball-impact-proof according to DIN VDE 0710-13
- Shock-resistant class IK10
- Slim Design

Applications

- Gym and sportshalls
- Schools
- Workplaces with higher mechanical demands



 **Ball-impact-proof luminaires**
acc. to DIN VDE 0710-13



SNP 8030

191



SN 8030

204



Single sided ball-impact and shock resistant exit luminaire. Powder-coated aluminium housing with slim design and brilliant pictograph illumination > 500cd/m². Perfect for use in environments with high mechanical stresses and in sports facilities.



Technical data

Viewing distance:	30 m	Apparent power:	10,4 VA
Material:	Sheet steel powder-coated	Inrush current:	6 A / 98 μs
Illuminant:	LEDs	Protection class:	I
Nominal voltage AC:	230V ±10% 50/60 Hz	Input terminals:	2.5mm ² feed through wiring
Nominal voltage DC:	176 - 264 V	Temperature ta:	-15...+40 °C
Nominal current AC:	45 mA	Impact resistance:	IK10
Nominal current DC:	18 mA		

Available colours Add colour code to the article no. e.g. 800 014 LXX

RAL 9016 (Traffic white): **L04** RAL 7015 (Slate grey): **L16** Special colour: **L99**

Articles

SNP 8030 LED J/SV

Art. no. 808 702

Wall mounting

Protection category: IP40

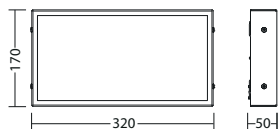

SNP 8030 WE LED J/SV

Art. no. 808 703

Recessed wall mounting

Protection category: IP40

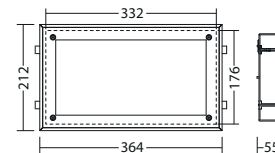



Double-sided ball-impact and shock resistant exit-luminaire. Powder-coated metal housing with slim design and brilliant pictograph illumination > 500cd/m². Perfect for use in environments with high mechanical stresses and in sports facilities.

**Technical data**

Viewing distance:	30 m	Inrush current:	6 A / 98 µs
Material:	Sheet steel powder-coated	Protection class:	I
Illuminant:	LEDs	Input terminals:	2.5mm ² feed through wiring
Nominal voltage AC:	230V ±10% 50/60 Hz	Temperature ta:	-15...+40 °C
Nominal voltage DC:	176 - 264 V	Impact resistance:	IK10

Available colours Add colour code to the article no. e.g. 800 014 **LXX**

RAL 9016 (Traffic white): **L04** RAL 7015 (Slate grey): **L16** Special colour: **L99**

Articles**SNP 8030 D LED J/SV**

Art. no. 808 704

Ceiling mounting

Protection category: IP40

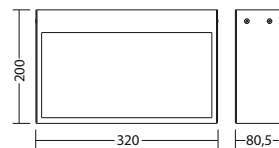







Ball-impact and shock resistant safety luminaires with state-of-the-art LED-technology for area or escape route illumination. Powder-coated aluminium housing with slim design, perfect for use in environments with high mechanical stresses and in sports facilities.



Technical data

Material:	Sheet steel powder-coated
Illuminant:	LEDs
Luminous flux:	310 lm
Nominal voltage AC:	230V ±10% 50/60 Hz
Nominal voltage DC:	176 - 264 V
Nominal current AC:	36 mA
Nominal current DC:	32 mA

Apparent power:	8,3 VA
Inrush current:	8 A / 50 µs
Protection class:	I
Input terminals:	2.5mm ² feed through wiring
Temperature ta:	-15...+40 °C
Impact resistance:	IK10



Minimum illumination 1.0 lx (middle of escape route), Maintenance factor 0.8

[m]	2.5	3.7	8.5
2.5	3.7	4.1	9.7
3.0	4.1	4.7	11.5
4.0	4.7	5.0	12.9
5.0	5.0	5.1	13.9
6.0	5.1	4.9	14.3
7.0	4.9	4.5	14.4
8.0	4.5	3.7	14.3
9.0	3.7	2.5	13.8
10.0	2.5		

Minimum illumination 1.0 Lux (area illumination), Maintenance factor 0.8

[m]	2.5	2.7	6.4
2.5	2.7	3.1	7.3
3.0	3.1	3.6	9.0
4.0	3.6	3.7	10.6
5.0	3.7	3.7	11.8
6.0	3.7	3.6	12.4
7.0	3.6	3.4	12.8
8.0	3.4	3.1	12.6
9.0	3.1	2.6	12.4
10.0	2.6		

Available colours Add colour code to the article no. e.g. 800 014 LXX

RAL 9016 (Traffic white): **L04** RAL 7015 (Slate grey): **L16** Special colour: **L99**

Articles

SN 8030 AP LED J/SV

Art. no. 808 709

ceiling mounting for exposed wiring

Protection category: IP40

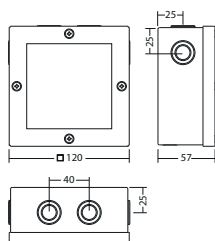

SN 8030 D LED J/SV

Art. no. 808 706

Ceiling mounting

Protection category: IP40

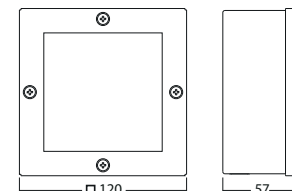

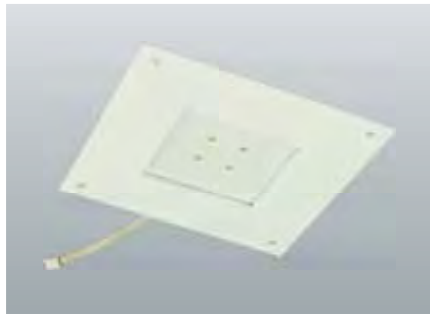

Ball-impact and shock resistant safety luminaires with state-of-the-art LED-technology for area or escape route illumination. Powder-coated aluminium housing with slim design, perfect for use in environments with high mechanical stresses and in sports facilities.



Technical data

Material:	Sheet steel powder-coated	Apparent power:	8,3 VA
Illuminant:	LEDs	Inrush current:	8 A / 50 μ s
Luminous flux:	310 lm	Protection class:	II
Nominal voltage AC:	230V \pm 10% 50/60 Hz	Input terminals:	2.5mm ² feed through wiring
Nominal voltage DC:	176 - 264 V	Temperature ta:	-15...+40 °C
Nominal current AC:	36 mA	Impact resistance:	IK10
Nominal current DC:	32 mA		



Minimum illumination 1.0 lx (middle of escape route), Maintenance factor 0.8

[m]	2.5	3.7	8.5
2.5	3.7	4.1	9.7
3.0	4.1	4.7	11.5
4.0	4.7	5.0	12.9
5.0	5.0	5.1	13.9
6.0	5.1	4.9	14.3
7.0	4.9	4.5	14.4
8.0	4.5	3.7	14.3
9.0	3.7	2.5	13.8
10.0	2.5		

Minimum illumination 1.0 Lux (area illumination), Maintenance factor 0.8

[m]	2.5	2.7	6.4
2.5	2.7	3.1	7.3
3.0	3.1	3.6	9.0
4.0	3.6	3.7	10.6
5.0	3.7	3.7	11.8
6.0	3.7	3.6	12.4
7.0	3.6	3.4	12.8
8.0	3.4	3.1	12.6
9.0	3.1	2.6	12.4
10.0	2.6		

Available colours Add colour code to the article no. e.g. 800 014 LXX

RAL 9016 (Traffic white): **L04** RAL 7015 (Slate grey): **L16** Special colour: **L99**

Articles

SN 8030 E LED J/SV

Art. no. 808 711

Recessed ceiling mounting

Protection category: IP20

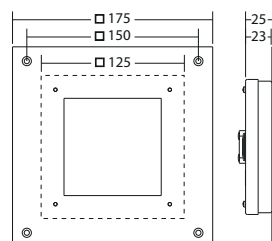

LED-Supply 230-3 J-SV SK II ext.

Art. no. 890 490

required

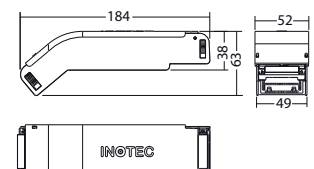



Moulded plastic luminaires

Universal emergency exit and safety luminaires



INOTEC offers a wide range of moulded plastic luminaires. The different housing sizes and versions allow you to personalise your emergency lighting. The range includes luminaires with one-, two- or three-sided light output, as well as luminaires with a high protection rating.

Advantages

- Different housing sizes
- Protection ratings up to IP65

Areas of application

- Workplaces
- Car parks
- Outdoor areas

	SNP 2130/2230	213
	SN 2100	216
	SNP 1006	219



Moulded plastic luminaires, made in Germany

The new moulded plastic luminaires

SN 2100, SN(P) 2130 and SNP 2230 were designed and constructed completely in house.

A close collaboration with our customers, designers and fitters allowed us to take into account requests and suggestions during the construction phase, so we have been able to satisfy all the demands placed on a modern moulded plastic luminaire.

The polycarbonate housing and all other components are produced in Germany. This guarantees that they meet the high standards for products Made in Germany.

With its optimised lighting technology, the SN 2100 LED is ideal not just for illuminating escape routes and open (anti-panic) areas, but also for illuminating halls or high-bay warehouses with high mounting heights.



Numerous mounting options thanks to the optional mounting adapter

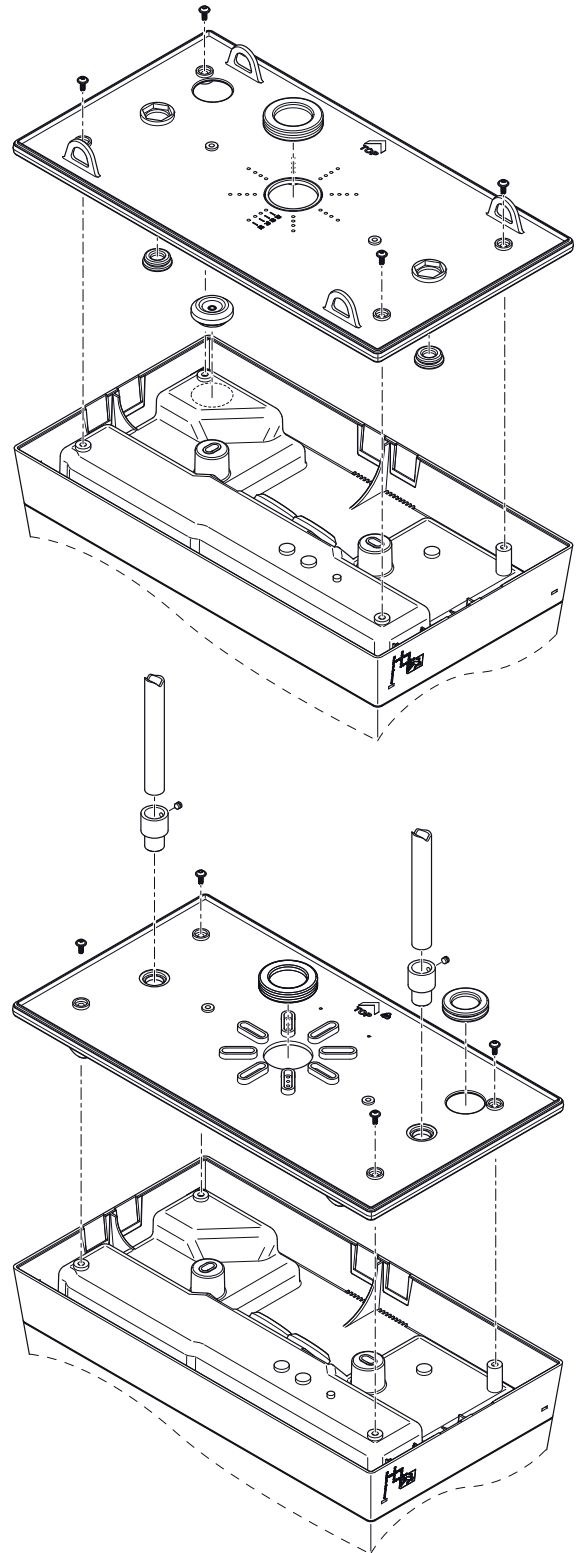



PC II



IP 65



UV resistant



The high protection rating and the housing's protective insulation allow use in difficult ambient conditions

The luminaires are made from high-quality UV-resistant polycarbonate that passes the 850°C hot-wire test and are optionally available in protection categories IP40 and IP65. The separate terminal compartment guarantees protection class II and the high protection rating IP65.



Easy to mount in both on-wall and in-wall installation

Quick to install in five easy steps

1. Install luminaire housing
2. Connect power cable
3. Fit illuminant
4. Click reflector into place
5. Close cover

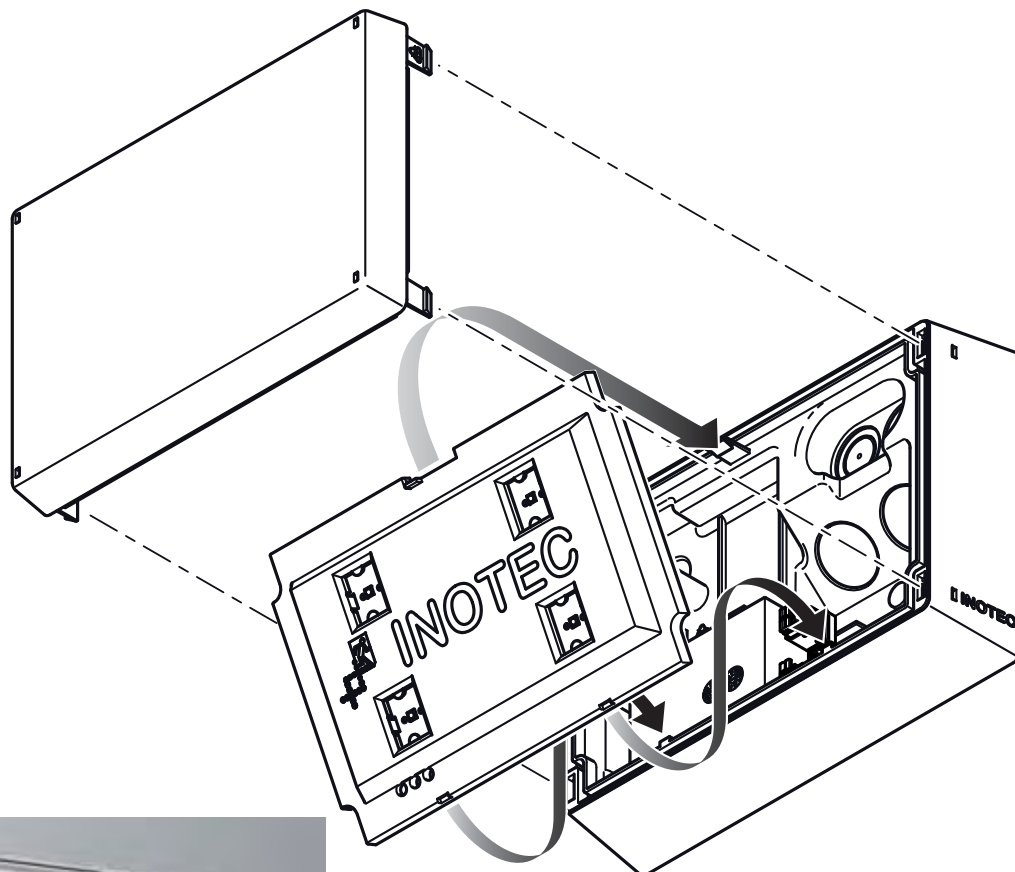

With on-wall installations, pre-moulded lateral openings can simply be punched out. A cable inlet ensures the power cable is inserted cleanly. The separate terminal compartment inside the luminaire further guarantees the high protection rating IP65. There are two mouldings on each of three sides of the luminaire, so that through-wiring is also possible.

A slightly raised surface on the back of the luminaires ensures that they can be mounted on uneven walls without compromising their tightness. The luminaires' special construction ensures there is no warping, which often leads to leaks in conventional housing constructions. The optional adapter for chain and pendulum mounting is also perfect for installation on trapezoidal sheets and rail systems.



3.01/S06

INOTEC



Single sided LED exit luminaire made of UV resistant, heat filament tested polycarbonate housing with optional side cable entry and comfortable installation space. Homogeneous illumination by state-of-the-art LED technology.



Technical data

Viewing distance:	30 m	Nominal current DC:	32 mA
Material:	Polycarbonate	Apparent power:	8,3 VA
Illuminant:	LEDs	Inrush current:	8 A / 50 μ s
Nominal voltage AC:	230V \pm 10% 50/60 Hz	Protection class:	II
Nominal voltage DC:	176 - 264 V	Input terminals:	2.5mm ² feed through wiring
Nominal current AC:	36 mA	Temperature ta:	-15...+40 °C

Articles

SNP 2130 LED J/SV Art. no. 802 607

Wall mounting

Protection category: IP40

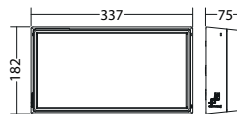

SNP 2130 LED J/SV Art. no. 802 610

Wall mounting

Protection category: IP65

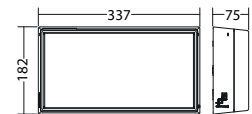





Double-sided LED emergency exit luminaire made of UV resistant, heat filament tested polycarbonate housing with optional side cable entry and comfortable installation space. Homogeneous illumination by state-of-the-art LED technology.



Technical data

Viewing distance:	30 m	Nominal current DC:	32 mA
Material:	Polycarbonate	Apparent power:	8,3 VA
Illuminant:	LEDs	Inrush current:	8 A / 50 μ s
Nominal voltage AC:	230V \pm 10% 50/60 Hz	Protection class:	II
Nominal voltage DC:	176 - 264 V	Input terminals:	2.5mm ² feed through wiring
Nominal current AC:	36 mA	Temperature ta:	-15...+40 °C

Articles

SNP 2230 LED J/SV

Art. no. 802 613

Ceiling mounting

Protection category: IP40

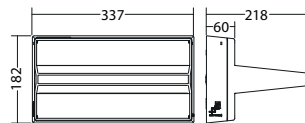

SNP 2230 LED J/SV

Art. no. 802 616

Ceiling mounting

Protection category: IP65

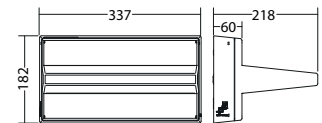

chain mounting adapter SN 2130

Art. no. 890 051

optional accessories

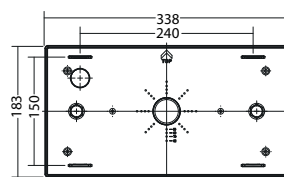

pendulum mounting adapter SN 2130

Art. no. 890 052

optional accessories

Protection category: IP40

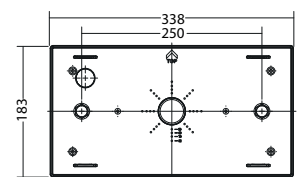



Universal LED downlight ideal for area or escape route illumination. UV resistant, heat filament tested polycarbonate housing with optional side cable entry and comfortable installation space.

Technical data

Material:	Polycarbonate	Nominal current DC:	32 mA
Illuminant:	LEDs	Apparent power:	8,3 VA
Luminous flux:	338 lm	Inrush current:	8 A / 50 µs
Nominal voltage AC:	230V ±10% 50/60 Hz	Protection class:	II
Nominal voltage DC:	176 - 264 V	Input terminals:	2.5mm ² feed through wiring
Nominal current AC:	36 mA	Temperature ta:	-15...+40 °C

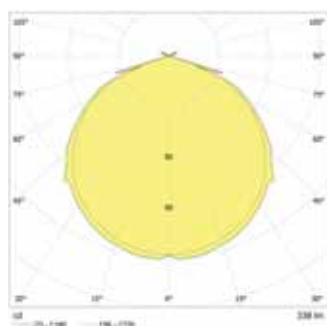

Minimum illumination 1.0 lx (middle of escape route), Maintenance factor 0.8

(m)	2.5	4.0	10.0	10.3	4.0
2.5	4.0	10.0	10.3	4.0	
3.0	4.3	10.8	11.0	4.3	
4.0	4.6	12.0	12.3	4.8	
5.0	4.7	12.8	13.1	4.9	
6.0	4.6	13.2	13.7	4.9	
7.0	4.3	13.4	13.9	4.4	
8.0	3.7	13.3	13.9	3.8	
9.0	2.5	13.0	13.3	2.7	
10.0	1.7	12.1	12.9	1.9	

Minimum illumination 1.0 Lux (area illumination), Maintenance factor 0.8

(m)	2.5	2.7	8.4	8.5	2.7
2.5	2.7	8.4	8.5	2.7	
3.0	2.9	9.1	9.2	2.9	
4.0	3.0	10.4	10.5	3.0	
5.0	3.0	11.5	11.6	3.0	
6.0	3.0	12.3	12.4	3.0	
7.0	3.2	12.5	12.6	3.2	
8.0	3.1	12.5	12.6	3.1	
9.0	2.8	12.2	12.1	2.8	
10.0	2.3	12.0	12.1	2.3	

Articles

SN 2100 LED J/SV

Art. no. 802 101

Ceiling mounting

Protection category: IP40

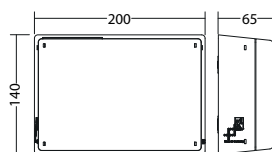

SN 2100 LED J/SV

Art. no. 802 104

Ceiling mounting

Protection category: IP65

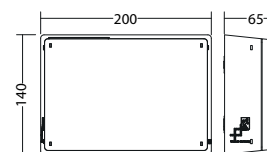

chain mounting adapter SN 2100

Art. no. 890 724

optional accessories

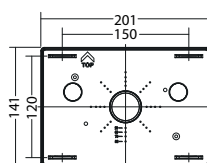



Universal LED downlight ideal for escape route illumination. UV resistant, heat filament tested polycarbonate housing with optional side cable entry and comfortable installation space.



Technical data

Material:	Polycarbonate	Nominal current DC:	32 mA
Illuminant:	LEDs	Apparent power:	8,3 VA
Luminous flux:	281 lm	Inrush current:	8 A / 50 µs
Nominal voltage AC:	230V ±10% 50/60 Hz	Protection class:	II
Nominal voltage DC:	176 - 264 V	Input terminals:	2.5mm ² feed through wiring
Nominal current AC:	36 mA	Temperature ta:	-15...+40 °C

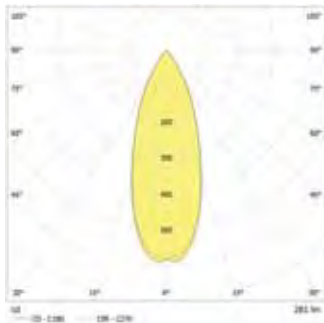

Minimum illumination 1.0 lx (middle of escape route), Maintenance factor 0.8

[m]	4.3	10.3	10.4	4.4
8.0	4.3	10.3	10.4	4.4
9.0	4.5	11.0	11.1	4.6
10.0	4.7	11.7	11.8	4.7
11.0	4.7	12.2	12.3	4.7
12.0	4.7	12.7	12.7	4.7
13.0	4.7	13.0	13.1	4.7
14.0	4.6	13.2	13.3	4.7
15.0	4.5	13.4	13.5	4.6
16.0	4.4	13.5	13.5	4.5
17.0	4.2	13.5	13.5	4.3
18.0	3.9	13.4	13.5	4.0
19.0	3.5	13.3	13.4	3.6
20.0	2.9	13.2	13.3	3.1

Minimum illumination 1.0 Lux (area illumination), Maintenance factor 0.8

[m]	3.5	9.5	9.5	3.6
10.0	3.5	9.5	9.5	3.6
11.0	3.5	10.1	10.1	3.5
12.0	3.5	10.5	10.5	3.5
13.0	3.5	11.1	11.1	3.5
14.0	3.4	11.5	11.5	3.4
15.0	3.2	11.8	11.8	3.2
16.0	3.2	11.8	11.8	3.2
17.0	3.1	12.0	12.0	3.1
18.0	3.0	12.0	12.0	3.0
19.0	2.9	11.8	11.8	2.9
20.0	2.7	11.3	11.3	2.7

Articles

SN 2100 T LED J/SV

Art. no. 802 113

Ceiling mounting

Protection category: IP40

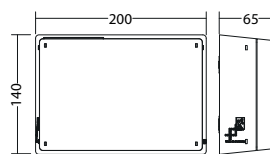

SN 2100 T LED J/SV

Art. no. 802 116

Ceiling mounting

Protection category: IP65

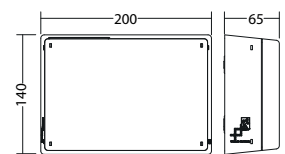

chain mounting adapter SN 2100

Art. no. 890 724

optional accessories

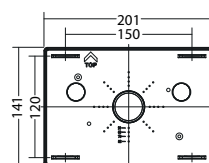



Universal LED downlight for mounting height up to 18m, ideal for illumination of 3m – 4m wide escape routes. UV resistant, heat filament tested polycarbonate housing with optional side cable entry and comfortable installation space.



Technical data

Material:	Polycarbonate	Nominal current DC:	32 mA
Illuminant:	LEDs	Apparent power:	8,3 VA
Luminous flux:	329 lm	Inrush current:	8 A / 50 µs
Nominal voltage AC:	230V ±10% 50/60 Hz	Protection class:	II
Nominal voltage DC:	176 - 264 V	Input terminals:	2.5mm ² feed through wiring
Nominal current AC:	36 mA	Temperature ta:	-15...+40 °C

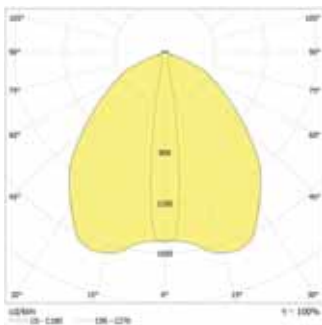

Minimum illumination 1.0 lx (middle of escape route), Maintenance factor 0.8

Mounting height [m]	Escape route width [m]	Maximum escape route width for area illumination with 1.25lx
8.0	7.1	18.0
9.0	7.6	20.5
10.0	8.0	21.6
11.0	8.2	22.5
12.0	7.0	21.1
13.0	7.1	22.2
14.0	7.1	22.6
15.0	7.0	23.3
16.0	7.4	24.6
17.0	6.8	24.7
18.0	6.4	24.6

Articles

SN 2100 TB LED J/SV

Art. no. 802 142

Ceiling mounting

Protection category: IP40

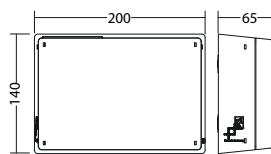

SN 2100 TB LED J/SV

Art. no. 802 139

Ceiling mounting

Protection category: IP65

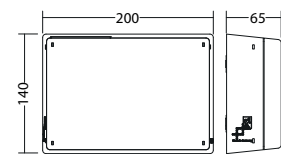

chain mounting adapter SN 2100

Art. no. 890 724

optional accessories

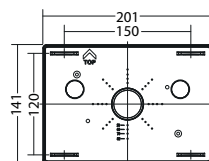



Double-sided LED emergency exit luminaire made of UV resistant, heat filament tested polycarbonate housing. Homogeneous pictograph illumination by state-of-the-art LED technology.

Technical data

Viewing distance:	14 m	Nominal current DC:	25 mA
Material:	Polycarbonate	Apparent power:	7,1 VA
Illuminant:	LEDs	Inrush current:	8 A / 50 μ s
Nominal voltage AC:	230V \pm 10% 50/60 Hz	Protection class:	I
Nominal voltage DC:	176 - 264 V	Input terminals:	2.5mm ² feed through wiring
Nominal current AC:	31 mA	Temperature ta:	-15...+40 °C

Articles

SNP 1006 LED J/SV

Art. no. 801 556

Wall or ceiling mounting

Protection category: IP20

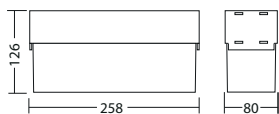

pendulum adapter 1006/1007

Art. no. 190 152

optional accessories

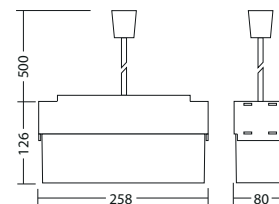

chain mounting adapter 1006/1007

Art. no. 190 153

optional accessories

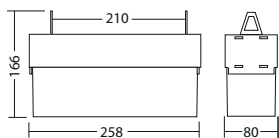

wall bracket 1006/1007

Art. no. 190 154

optional accessories

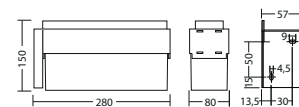









Dynamic emergency exit sign luminaires FL-Series

Dynamic emergency exit luminaires of the FL series can be used to indicate, block or change escape routes depending on a fire event.

Luminaires of the types FL 1530, FL 7188 and FL 808 are particularly suitable for combining dynamic and static luminaires, as they are also available as static emergency exit luminaires.

Instead of the static direction indicator, an arrow matrix indicates the safe route in the event of a fire, or closes off a smoke-filled area.

The FL range offers luminaires for almost every application – from robust stainless-steel luminaires with a high protection class to state-of-the-art, elegantly designed luminaires from the 'Straight Line' range.

	FL 1530.1	222
	FL 7188 / 7288	226
	FL 808 / 828	230
	FS 1100	231
	FL 3100	232
	FL 804.1	233





Dynamic single-sided Straight-Line emergency exit sign luminaire made of high quality, powder-coated aluminium. Ideal to display the safe escape route depending on the smoke situation inside a building.

Technical data

Viewing distance:	30 m
Material:	Aluminium powder-coated
Illuminant:	LEDs
Nominal voltage AC:	230V ±10% 50/60 Hz
Nominal voltage DC:	176 - 264 V
Nominal current AC:	62 mA

Nominal current DC:	33 mA
Apparent power:	14,30 VA
Protection class:	I
Input terminals:	1,5mm ²
Temperature ta:	-15...+40 °C

Available colours Add colour code to the article no. e.g. 800 014 LXX

RAL 9016 (Traffic white): **L04** Special colour: **L99** 

Articles

FL 1530 PM LED 230V

Art. no. 800 141 V

Parallel wall mounting

Protection category: IP40

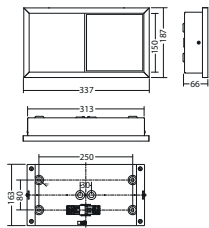

FL 1530 WE LED 230V

Art. no. 800 143 V

Recessed wall mounting

Protection category: IP40

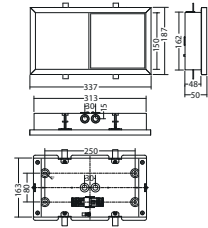



Dynamic double-sided straight-line emergency exit sign luminaire made of high quality, powder-coated aluminium. Ideal to display the safe escape route depending on the smoke situation inside a building. For single-sided use, the current consumption is reduced by 50%.

Technical data

Viewing distance:	30 m	Nominal current DC:	66 mA
Material:	Aluminium powder-coated	Apparent power:	28,60 VA
Illuminant:	LEDs	Protection class:	I
Nominal voltage AC:	230V ±10% 50/60 Hz	Input terminals:	1,5mm ²
Nominal voltage DC:	176 - 264 V	Temperature ta:	-15...+40 °C
Nominal current AC:	124 mA		

Available colours Add colour code to the article no. e.g. 800 014 LXX

RAL 9016 (Traffic white): **L04** Special colour: **L99**

Articles
FL 1530 D LED 230V

Art. no. 800 147 V

Ceiling mounting

Protection category: IP40

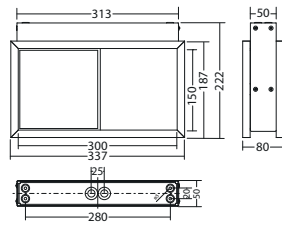
FL 1530 P LED 230V

Art. no. 800 145 V

Pendulum mounting

Protection category: IP40

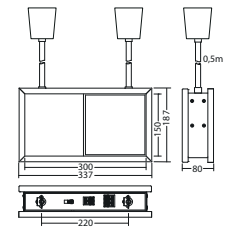
FL 1530 WA LED 230V

Art. no. 800 149 V

Wall bracket mounting

Protection category: IP40

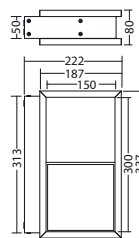



Dynamic single-sided emergency exit sign luminaire made of high quality aluminium profile. Ideal to display the safe escape route depending on the smoke situation inside a building.

Technical data

Viewing distance:	35 m	Nominal current DC:	33 mA
Material:	Aluminium	Apparent power:	14,30 VA
Illuminant:	LEDs	Protection class:	I
Nominal voltage AC:	230V ±10% 50/60 Hz	Input terminals:	1,5mm ²
Nominal voltage DC:	176 - 264 V	Temperature ta:	-15...+40 °C
Nominal current AC:	62 mA		

Articles

FL 7188 LED 230V

Art. no. 800 101 V

Wall mounting

Protection category: IP40

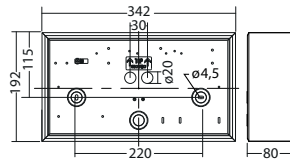



Dynamic double-sided emergency exit sign luminaire made of high quality aluminium profile. Ideal to display the safe escape route depending on the smoke situation inside a building.

For single-sided use, the current consumption is reduced by 50%.

Technical data

Viewing distance:	35 m
Material:	Aluminium
Illuminant:	LEDs
Nominal voltage AC:	230V ±10% 50/60 Hz
Nominal voltage DC:	176 - 264 V
Nominal current AC:	124 mA

Nominal current DC:	66 mA
Apparent power:	28,60 VA
Protection class:	I
Input terminals:	1,5mm ²
Temperature ta:	-15...+40 °C

Articles
FL 7288 D LED 230V

Art. no. 800 103 V

Ceiling mounting

Protection category: IP40

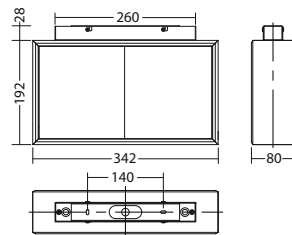
FL 7288 K LED 230V

Art. no. 800 109 V

Chain mounting

Protection category: IP40

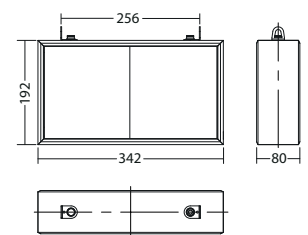
FL 7288 P LED 230V

Art. no. 800 107 V

Pendulum mounting

Protection category: IP40

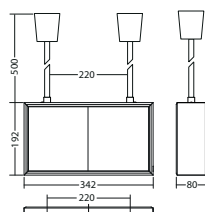
FL 7288 WA LED 230V

Art. no. 800 105 V

Wall bracket mounting

Protection category: IP40

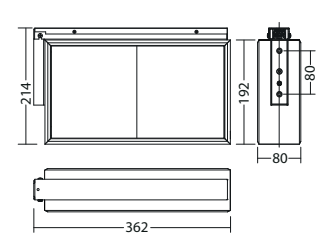







Dynamic single-sided emergency exit luminaire made of robust stainless steel with high protection category. Ideal to display the safe escape route depending on the smoke situation inside a building.

Technical data

Viewing distance:	30 m	Nominal current DC:	33 mA
Material:	Stainless steel	Apparent power:	14,30 VA
Illuminant:	LEDs	Protection class:	I
Nominal voltage AC:	230V ±10% 50/60 Hz	Input terminals:	1,5mm ²
Nominal voltage DC:	176 - 264 V	Temperature ta:	-15...+40 °C
Nominal current AC:	62 mA		

Available colours Add colour code to the article no. e.g. 800 014 **LXX**

stainless steel: **L30** ■ RAL 7015 (Slate grey): **L16** ■ RAL 9016 (Traffic white): **L04** □ Special colour: **L99** 🌈

Articles

FL 808 LED 230V

Art. no. 800 181 V

Wall mounting

Protection category: IP65

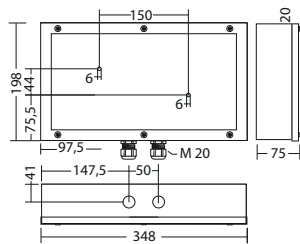



Dynamic double-sided emergency exit luminaire made of robust stainless steel with high protection category. Ideal to display the safe escape route depending on the smoke situation inside a building. For single-sided use, the current consumption is reduced by 50%.

Technical data

Viewing distance:	30 m	Nominal current DC:	66 mA
Material:	Stainless steel	Apparent power:	28,60 VA
Illuminant:	LEDs	Protection class:	I
Nominal voltage AC:	230V ±10% 50/60 Hz	Input terminals:	1,5mm ²
Nominal voltage DC:	176 - 264 V	Temperature ta:	-15...+40 °C
Nominal current AC:	124 mA		

Available colours Add colour code to the article no. e.g. 800 014 LXX

stainless steel: **L30** ■ RAL 7015 (Slate grey): **L16** ■ RAL 9016 (Traffic white): **L04** □ Special colour: **L99** 🌈

Articles
FL 828 K LED 230V

Art. no. 800 183 V

Chain mounting

Protection category: IP65

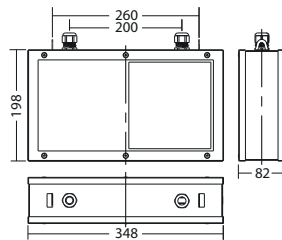
FL 828 WA LED 230V

Art. no. 800 185 V

Wall bracket mounting

Protection category: IP65

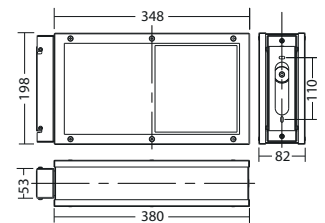





Dynamic Escape Route luminaire for floor installation, including run light functionality. Ideal to display the safe escape route depending on the smoke situation inside a building. Power supply by PSU 48.

Technical data

Material:	Stainless steel	Protection class:	III
Illuminant:	LEDs	Input terminals:	2,5mm ² feed through wiring
Nominal voltage DC:	48 V ±10 %	Temperature ta:	-15...+40 °C
Nominal current DC:	35 mA		

Available colours Add colour code to the article no. e.g. 800 014 LXX

RAL 7015 (Slate grey): **L16** ■ RAL 9006 (White aluminium): **L10** ■

Articles

FS 1100 BE D.E.R. 48V Art. no. 800 161

Flush floor installation

Protection category: IP65

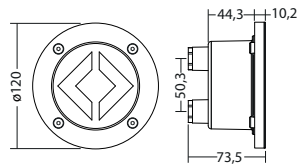

FS 1100 TE D.E.R. 48V Art. no. 800 160

Flush carpet installation

Protection category: IP65

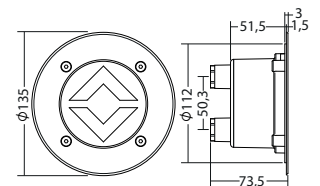



Dynamic escape route segment luminaire for recessed wall installation and modular design with customisable assembly. Ideal to display the safe escape route depending on the smoke situation inside a building. With integrated LED safety luminaire.

Technical data

Material:	Sheet steel powder-coated	Nominal current DC:	36 mA
Illuminant:	LEDs	Apparent power:	8,00 VA
Nominal voltage AC:	230V ±10% 50/60 Hz	Protection class:	I
Nominal voltage DC:	176 - 264 V	Input terminals:	1,5mm ²
Nominal current AC:	35 mA	Temperature ta:	-15...+40 °C

Available colours Add colour code to the article no. e.g. 800 014 **LXX**

RAL 9016 (Traffic white): **L04** RAL 7015 (Slate grey): **L16** Special colour: **L99** 

Articles

FL 3100 WE LED 230V Art. no. 800 152 V

Recessed wall mounting

Protection category: IP40

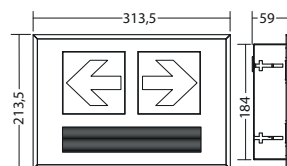



Dynamic escape route segment luminaire with run-light function made of robust stainless steel with high protection category.
 Ideal to display the safe escape route depending on the smoke situation inside a building.

Technical data

Material:	Stainless steel
Illuminant:	LEDs
Nominal voltage DC:	48 V ±10 %
Nominal current DC:	35 mA

Protection class:	III
Input terminals:	2,5mm ² feed through wiring
Temperature ta:	-15...+40 °C

Available colours Add colour code to the article no. e.g. 800 014 LXX

stainless steel: **L30** ■ Special colour: **L99** ■

Articles
FS 804.1 W D.E.R. 48V Art. no. 800 028

Wall mounting

Protection category: IP65

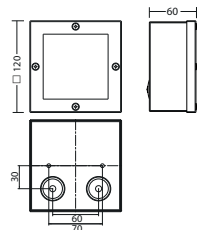
FS 804.1 WA D.E.R. 48V Art. no. 800 027

Wall bracket mounting

Protection category: IP65

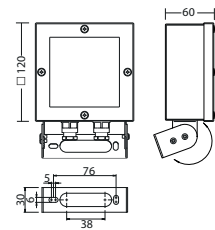
FS 804.1 WAP D.E.R. 48V Art. no. 800 029

Wall bracket mounting

Protection category: IP65

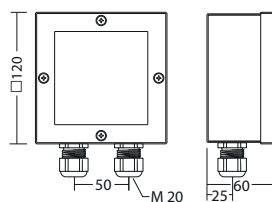
FS 804.1 WE D.E.R. 48V Art. no. 800 031

Recessed wall mounting

Protection category: IP65

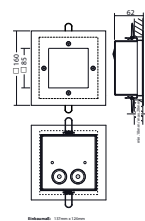



EX-luminaire

Emergency exit sign and safety luminaires

The Ex luminaire series offers emergency exit sign and safety luminaires in 24V technology for hazardous areas in zones 1, 2, 21 and 22. The luminaires can be used as safety luminaires for wall and ceiling mounting and with pictogram as escape sign luminaires for wall mounting.

Advantages

- 24V technology
- Versatile mounting possibilities

Applications

- Explosion-hazardous zones 1, 2, 21 and 22
- Laboratory facilities
- Painting booths
- Chemical industry



EX 7000

237







Ex-safety- /exit-luminaire for zone 1, 2, 21, 22. Made of high-quality glass fiber reinforced polyester resin for wall or ceiling mounting.

Technical data

Viewing distance:	30 m	Nominal current DC:	25 mA
Material:	Polyester, Polycarbonate	Apparent power:	6,5 VA
Illuminant:	LEDs	Effective power:	6,0 W
Nominal voltage AC:	230V ±10% 50/60 Hz	Inrush current:	35 A / 95 µs
Nominal voltage DC:	176 - 264 V	Protection class:	I
Nominal current AC:	28 mA	Temperature ta:	-30...+60 °C

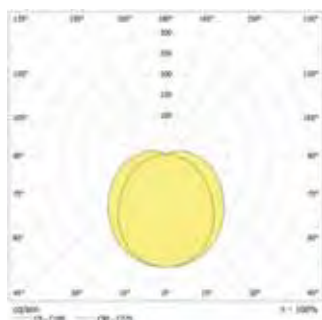

Minimum illumination 1.0 lx (middle of escape route), Maintenance factor 0.8

Beam diameter [m]	1	2	3	4
2.0	2.8	9.4	11.1	4.4
3.0	4.3	10.1	12.7	4.9
4.0	4.7	12.0	13.7	5.2
5.0	4.8	12.8	14.5	5.3
6.0	4.8	13.3	14.9	5.2
7.0	4.6	13.6	15.1	5.0
8.0	4.1	13.6	15.0	4.5
9.0	3.4	13.4	14.6	3.7
10.0	2.0	12.9	14.0	2.2

Articles

EX 7102 LED J/SV

Art. no. 807 004

Wall or ceiling mounting

Protection category: IP66

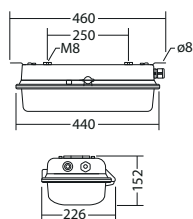

Your key contact for emergency lighting!

Since its foundation in 1995 INOTEC Sicherheitstechnik GmbH has grown into a medium-sized company with more than 250 employees. We became a firm partner for a lot of planner and installer in the field of emergency and safety lighting. This means for us that you can count with our expertise at any time during your project.

Planning

In addition to the R&D of our products, we also rely on Germany as a business location for production. Therefore we work together with high qualified German suppliers. The final assembly is done at our headquarters in Ense, Germany. Because of the wide product range a sophisticated logistics is needed to guarantee short delivery times.



Our nationwide distribution team supports you early within the country and abroad with the project planning and the selecting of a suitable emergency lighting system.

To offer you shorter ways and more availability for technical and business questions we have four distribution centres in Pinneberg, Potsdam, Nördlingen and Ense.



R&D

Safety is the most important quality feature of our products. For this reason they are developed and tested by own INOTEC employees / quality assurance. Thereby, we cover the complete process of construction, hardware and software development. Having this competence and knowledge in house, we can advise you in the best way. If necessary products can be adapted to your project requirements.

Production / Logistics



The art of being local

INOTEC Sicherheitstechnik GmbH is represented in many countries of Europe and the Middle East by agencies and strategic partners for sales and service purposes. Working closely with our export department in our parent company in Germany, we develop together the required know-how to fulfill all practical and theoretical requirements of emergency lighting applications. Thus, we ensure commercial and technical support for emergency lighting applications on the spot by taking local standards into account.

Your benefits:

- + Contact person in your region
- + Consideration of local standards
- + On-site training in practical and theoretical subject

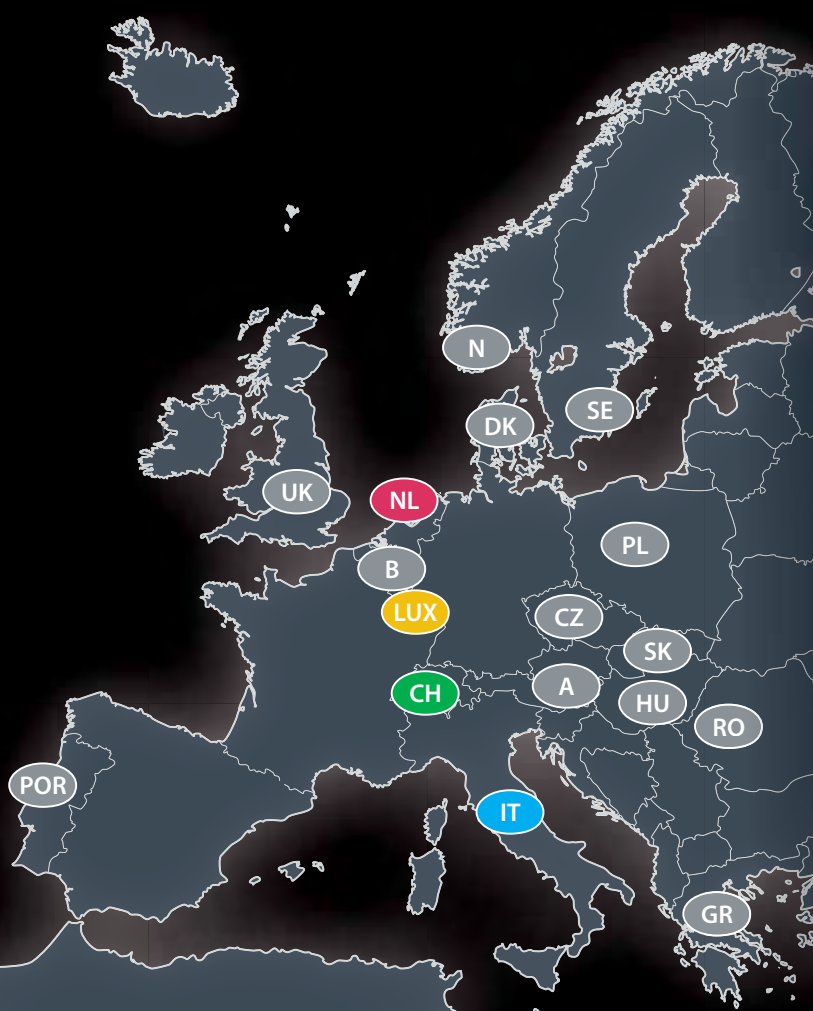

INOTEC Sicherheitstechnik (Schweiz) AG

✉ Industriepark 5
CH-8610 Uster
☎ info@inotec-licht.ch
☎ +41 43 366 4400

INOTEC Licht S.R.L.

✉ Via Nuova Circonvallazione 69
I - 47924 Rimini
☎ ufficio.tecnico@inotec-licht.it
☎ +39 541 7919 11

Lux-INOTEC Sicherheitssysteme S.A

✉ Zone Industrielle Rolach, Hall 4
L - 5280 Sandweiler
☎ info@inotec.lu
☎ +352 26 66 55 88

INOTEC Noodverlichting BV

✉ Koningslijn 14
NL-7312 GH Apeldoorn
☎ info@inotec-noodverlichting.nl
☎ + 31 55 355 1201

Inotec Middle East FZC

✉ P.O. Box 9338
SAIF Zone, Sharjah
U.A.E
☎ info@inotecmena.com
☎ +971 4 3277 605



Find your local contact person!

www.inotec-licht.de/kontakt/internationale-partner

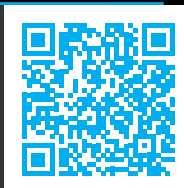

On spot for you

Your sales representative, responsible for your area is your contact person and gets supported by the technical and commercial internal sales in the local office. As a team, they take care of your concerns regarding safety lighting and support your project design.

Training facilities are available in every sales centre to encourage the dialogue between INOTEC and the customers. Beside theoretical topics like emergency lighting standards, practical knowledge on INOTEC products is presented in a comprehensible and up-to-date manner.

- + Your benefits: Personal, local contact person
- + Focus on your regional requirements and expectations
- + Product training and knowledge transfer in your regional sales centre



Find your local contact person!

www.inotec-licht.de/kontakt/ansprechpartner/



Sales centre North

- ✉ Osterholder Allee 2
25421 Pinneberg
- 🌐 buero-nord@inotec-licht.de
- ☎ +49 4101 58 78 -10

Sales centre East

- ✉ Am Buchhorst 34
14478 Potsdam
- 🌐 buero-ost@inotec-licht.de
- ☎ +49 331 87 00 0 -646

Sales centre South

- ✉ Schäufelinstraße 14
86720 Nördlingen
- 🌐 buero-sued@inotec-licht.de
- ☎ +49 9081 80 57 9 -10

Sales centre West

- ✉ Am Buschgarten 17
59469 Ense
- 🌐 buero-west@inotec-licht.de
- ☎ +49 2938 97 30 -775

Service is the key



For us as the manufacturer an all-inclusive "After-Sales-Service" for our customer is very important. Our free technical hotline is available in Germany for any kind of technical questions concerning our products. Our own service technicians are ready for basic programming, extending, inspections and repairing. To offer the best support to our clients, we only work with our own technicians and do not refer to any subcontractors. Outside of Germany we have employees trained by INOTEC, who offer the best service.

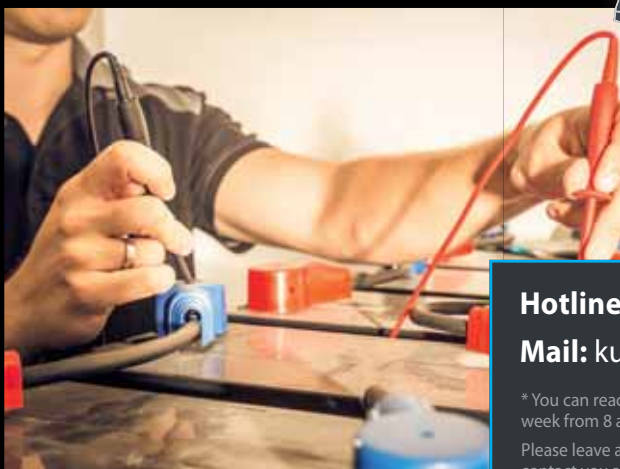

Hotline: +49 2938-9730-777 *

Mail: kundendienst@inotec-licht.de

* You can reach our hotline within the business hours during the week from 8 am till 4.30 pm.

Please leave a message outside of our business hours, so we can contact you as soon as possible.



Luminaire categories

High protection category >IP54

Type	Category	Page
SN 6114	step luminaire	135
SN 6204.2	wall luminaire	137
SN 804	stainless steel luminaire	153
SN 8040	downlight	191
SNP 808 / SNP 828	stainless steel luminaire	148
FL 808 / FL 828	stainless steel luminaire	228
SN 2100	polycarbonate luminaire	216
SNP 2130 / SNP 2230	polycarbonate luminaire	213
SN 8500	downlight	185

Protection class II

Type	Category	Page
SN 2100/2130	polycarbonate luminaire	216
SN 2420	exit luminaire	127
SNP 2435	exit luminaire	129
SN 9100	downlight	159
SN 9400	downlight	165
SNP 2130 / SNP 2230	polycarbonate luminaire	213
SNP 2004.1 / SN 2004.1	wall and step luminaire	140

D.E.R. Dynamic Escape Routing

Deeper information about the D.E.R. system and luminaires can be found in the specific D.E.R. catalogue.

Dynamic exit sign luminaires

With the dynamic emergency exit luminaires from the FL-range, escape routes can be signposted, blocked or changed, depending on the fire event.

The luminaire types FL 1530.1, FL 7188 and FL 808 are suitable especially for a mixture use of dynamic and static exit sign luminaires in a building, as these luminaire types are also available in a static version. Instead of the standard exit sign, a LED matrix shows the safe way in case of emergency and blocks the smoky areas.

Type	Category	Page
FL 1530.1	straight-line	222
FL 7188 / 7288	aluminium profile luminaire	224
FL 808 / FL 828	stainless steel luminaire	228
FL 3100	wall luminaire	232
FS 1100	recessed floor luminaire	231
FS 804	stainless steel luminaire	233



INOTEC Sicherheitstechnik GmbH
Am Buschgarten 17
D - 59469 Ense

Tel +49 2938 97 30 -0

Fax +49 2938 97 30 -29

info@inotec-licht.de

www.inotec-licht.de

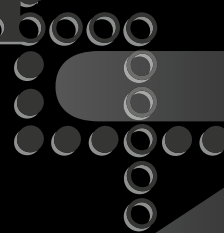

INOTEC
Sicherheitstechnik GmbH