

CPS 220/48.1/SV

Central Battery System



INOTEC Sicherheitstechnik GmbH

Emergency lighting systems & luminaires



INOTEC Sicherheitstechnik GmbH is an innovative company located in the Westphalian Ense Höingen. The company prides in having its own development, design, production complete with national and international sales department.

Since establishing in 1995, it has now turned into a globally active company with famous patents like JOKER technology and awards for being the most innovative company in Germany in the field of emergency lighting, under its belt.

The production and office facilities at the German headquarters have grown to around 14,000m² with over 280 employees.

General information

With the publication of this catalogue, all previous versions lose their validity. During the period of validity of this catalogue, we reserve the right to make technical and formal changes to our products in order to improve them or to take account of changes in legal regulations. We are pleased to provide current data on request.

All LED luminaires are supplied incl. LED illuminant.

Industrial property rights exist for a large part of the products. Current product information can be found on our homepage at www.inotec-licht.de





Content

International Contacts	4
Overview/ features of CPS 220/48.1/SV	5 - 6
System Components and options Control Module	7
System Components and options ▪ Changeover Module ▪ Charger	8
Monitoring Components and options ▪ LSA8.1 (24V) ▪ LSA8.1 (230V) ▪ LSA 3.1 (230V)	9
Monitoring Components and options ▪ DPU 8 ▪ DPU B.2 ▪ DPU ▪ RIF 5	10 - 11
BCS – Battery Control System	12
Addressable interface and options ▪ J-SV-Modul../S ▪ J-ET 9/24 SV ▪ DALI-SV-Modul ▪ BUS-Interruptor Modul	13
Remote/Central monitoring options ▪ Central Monitoring Software ▪ CPS MTB	14 - 15
Technical data and system overview	16 - 18
Example of overall riser	19



The art of being local

INOTEC Sicherheitstechnik GmbH is represented in many countries of Europe and the Middle East by agencies and strategic partners for sales and service purposes. Working closely with our export department in our parent company in Germany, we develop together the required know-how to fulfill all practical and theoretical requirements of emergency lighting applications. Thus, we ensure commercial and technical support for emergency lighting applications on the spot by taking local standards into account.

Your benefits:

- + Contact person in your region
- + Consideration of local standards
- + On-site training in practical and theoretical subject

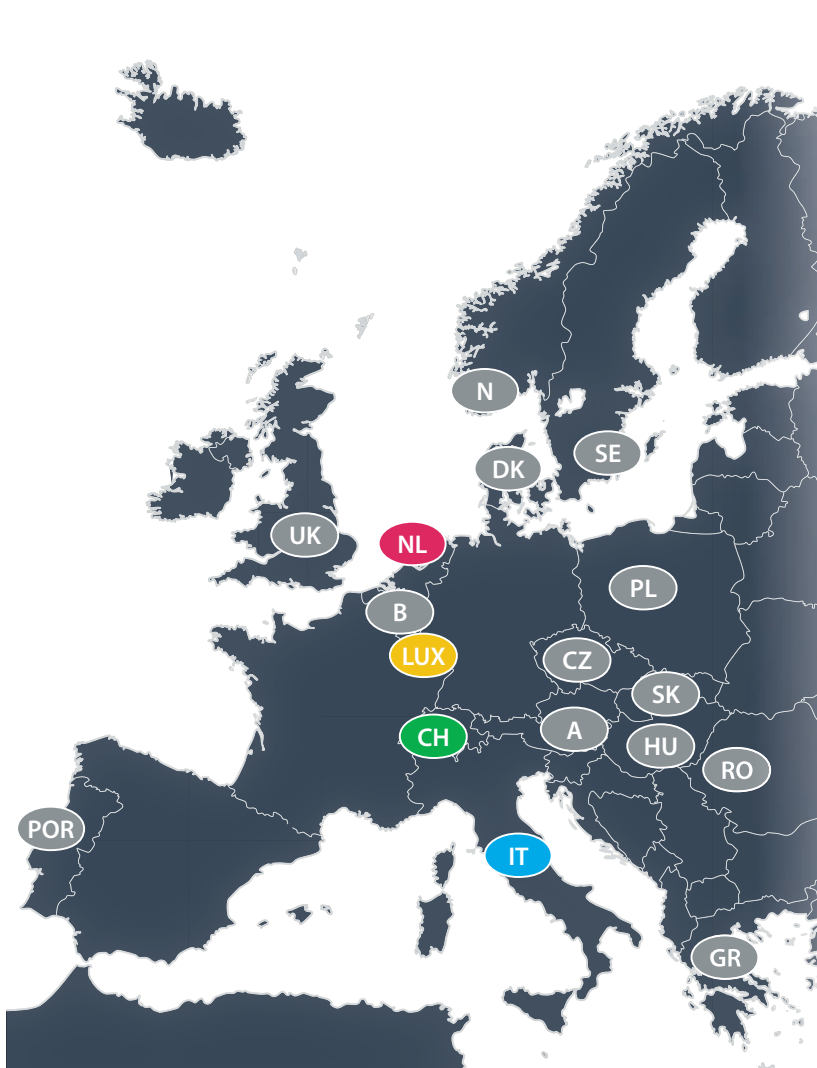

INOTEC Sicherheitstechnik (Schweiz) AG

✉ Industriepark 5
CH-8610 Uster
🌐 info@inotec-licht.ch
☎ +41 43 366 4400

INOTEC Licht S.R.L.

✉ Via Nuova Circonvallazione 69
I – 47924 Rimini
🌐 ufficio.tecnico@inotec-licht.it
☎ +39 541 7919 11

Lux-INOTEC Sicherheitssysteme S.A

✉ Zone Industrielle Rolach, Hall 4
L – 5280 Sandweiler
🌐 info@inotec.lu
☎ +352 26 66 55 88

INOTEC Noodverlichting BV

✉ Koningslijn 14
NL-7312 GH Apeldoorn
🌐 info@inotec-noodverlichting.nl
☎ + 31 55 355 1201

Inotec Middle East FZC

✉ P.O. Box 9338
SAIF Zone, Sharjah
U.A.E
🌐 info@inotecmena.com
☎ +971 4 3277 605

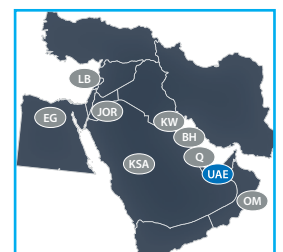

Find your local contact person!

www.inotec-licht.de/kontakt/internationale-partner

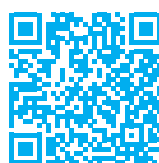

The CPS 220 series covers various load requirements and housing sizes. Joker technology, individual luminaire and circuit monitoring are our standard.

System features

- ▶ Modular design in sheet steel, various enclosure sizes for mains, substation, battery racks and battery enclosures
- ▶ Up to 96 circuits (48 by main panel/ 48 by substations) with 20 addresses in each circuit can be monitored by the CPS controller
- ▶ Low maintenance and service cost due to central monitoring of stations and all connected luminaires and option of BCS – Battery Control System
- ▶ Automated or manually starting function and duration testing facility with integral logbook for status and failure monitoring
- ▶ Earth failure measurement and test facility
- ▶ Isolating terminals for easy earth failure measurements
- ▶ Patented 'Joker-Technology' function for mixed operation of maintained, non-maintained and switched maintained luminaires on one line
- ▶ Sealed lead acid gas recombination OGI batteries with greater than 10 year design life
- ▶ Advanced BCS – Battery Control System (optional) that helps identify individual battery block status with voltage and temperature, logs the results in the control module in each panel and identify several types of battery failures in a battery block

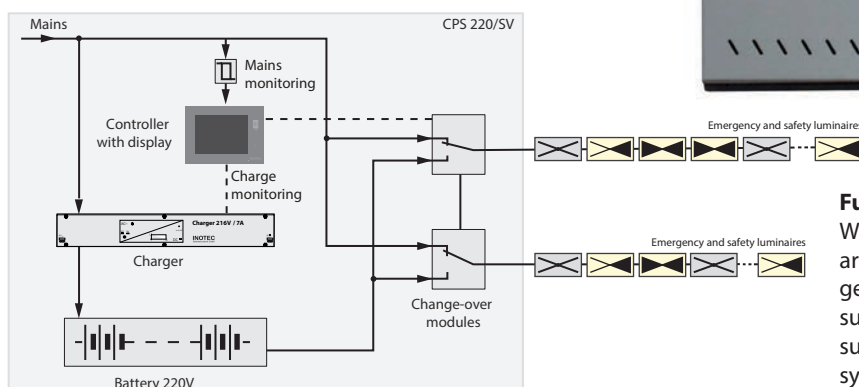

Function principle:

With functional mains all connected consumers are supplied with mains and the battery is charged / monitored. If mains fails or a partial light sub-distribution or circuit failure is detected the supply is triggered by the emergency lighting system.



The modular construction of our panels can be flexibly adapted to suit project requirements and higher loads. One such example with a fully loaded CPS panel with additional chargers is shown below. Similar construction changes are made from time to time depending on the project requirement.

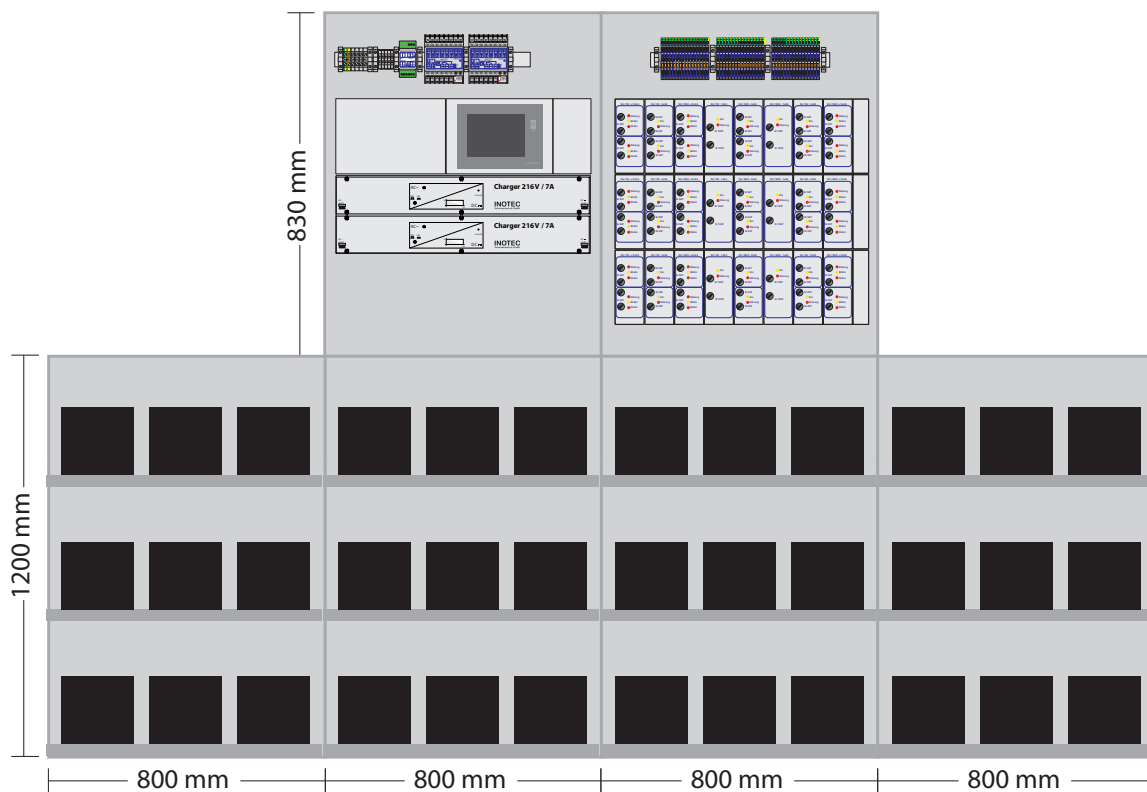

Microprocessor controlled freely programmable, with non volatile memory TFT touch controller with build in SD-card.

- 5" touchscreen with intuitive graphical user interface
- Programming, monitoring and control of upto 96 circuits (1920 luminaires)
- Switching modes freely programmable
- Single luminaire monitoring (SV)/circuit monitoring (SKU)
- Programmable automatic function test/battery duration test
- USB interface for uploading/downloading complete system configuration programming, connection of keyboard/PCL-compatible Printer
- Password protection
- Blocking function for complete system/ circuits
- Integrated INOWeb/INOView network interface
- Interface for BMS or other external monitoring systems
- Open protocol higher order interface with BMS via built in gateway.
- Display of complete status information of the system including battery voltage/ battery current and battery capacity
- Display of failure information for every circuit or individual luminaire incl destination text info
- Display of charger failure
- Display of voltage and temperature of each individual battery block when using (optional) INOTEC Battery Control System BCS.
- Deep discharge protection and display
- Setting delay on mains return 1-15min
- Log book entries for more than 2 years
- Earth leakage monitor with test and display facility
- Electronically monitored 24V loop for monitoring of any number of sub distribution boards
- Manual reset

Central Monitoring

- Connected for Central Monitoring to display the complete status of the CPS systems as a HTML page via standard web browser or an ethernet.
- IP address programmable or allocated via a DHCP-server
- Built in Modbus/IP gateway for BMS monitoring
- Ethernet RJ45 port
- Data transmission upto end luminaire status including text location details of end luminaires possible

CPS - TFT Touch Controller



- Modular slide in circuit module with 2 pole fuse protection for every circuit
- Modular modules slide on rigid rails with construction compliant to EN standards relating to central power supply systems
- No access to live components at any time
- Easy to replace the modules without the need to de-energise the panels – hot swap facility
- Variants :
 - SKE 2x3A - 2 circuits each 3A
 - SKE 1x6A - 1 circuit of 6A
- Single luminaire and circuit monitoring with JOKER function for upto 20 luminaires
- Monitoring without dataline
- LED in the front facia for circuit status info
- Internally wired to terminals 4mm², with isolating neutral
- Fuse covering AC and DC operation:
 - 5AT/250V for SKE 2x3A
 - 10AT/250V for SKE 1x6A
- Fuses easily accessible from front facia
- Fuses for no-load and short circuit protection of each outgoing circuit
- Max. inrush current per circuit 250A/500µs
- Switchover time adjustable from 400ms to 3000ms

Change-over device SKE



- Microprocessor controller, modular, plug in, service friendly 19" housing
- Variants :
 - 220V/3A
 - 220V/7A
- Temperature compensated, working to I/U characteristic
- Built in Trickle & Boost charging function
- LED in the front facia for Power On
- Charge/discharge current information including failure information available in the CPS controller display
- Fuse covering input and output internally
- Temperature and load controlled internal ventilator
- Constant battery circuit monitoring within intervals of 5 minutes or less with fault display at the CPS controller in case of:
 - Blown battery fuse
 - Missing or defective battery block
 - Faulty charger
 - Open battery circuit
 - Battery voltage too high/low

Charger216V/3A



Charger 216 V/7A



- Sub circuit monitor with 8 inputs suitable for DIN rail mounting
- Each of the 8 galvanically separated channels can be used to monitor distribution board/ distribution board outgoing
- Changeover devices are linked/ assigned by software via the CPS control module
- Possible to assign/activate any number of changeover device circuits to each channel
- Possible to assign three different channels to each changeover device circuit
- Input voltage for each channel to be 15V - 30V DC
- Three phase monitoring with DPÜ/Bus functionality built in – activation level $0.85 \times U_N$

LSA 8.1 / 24V

Light switch application 8 channels

Art. no. 100893235

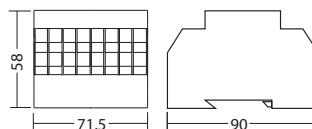

- Sub circuit monitor with 8 inputs suitable for DIN rail mounting
- Each of the 8 galvanically separated channels can be used to monitor distribution board/ distribution board outgoing
- Changeover devices are linked/ assigned by software via the CPS control module
- Possible to assign/activate any number of changeover device circuits to each channel
- Possible to assign three different channels to each changeover device circuit
- Input voltage for each channel to be 230V AC
- Three phase monitoring with DPÜ/Bus functionality built in – activation level $0.85 \times U_N$

LSA 8.1 / 230V

Light switch application 8 channels

Art. no. 100893437



- Sub circuit monitor with 3 inputs suitable for DIN Rail mounting
- Each of the 3 channels can be used to monitor distribution board/ distribution board outgoing
- Changeover devices are linked/ assigned by software via the CPS Control Module
- Possible to assign/activate any number of changeover device circuits to each channel
- Possible to assign three different channels to each changeover device circuit
- Input voltage for each channel to be 230V AC
- Common neutral
- Available as LSA 3.1 (24V) option as well

LSA 3.1 / 230V

Light switch application 3 channels

Art. no. 100893841

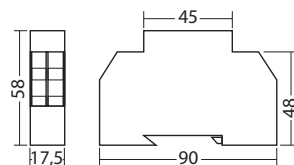

Note: For detailed technical data on each module including options, please contact Regional office of INOTEC



- Sub circuit monitor with 8 inputs suitable for DIN rail mounting
- Current loop can be wired to LSA8.1 channel in CPS for assignments to changeover devices
- Three phase monitoring with activation level $0.85 \times U_N$
- Voltage 230V/400V AC 50/60Hz, Threshold $0.85 \times U_N$

DPÜ 8

Phase monitoring module

Art. no. 101434213

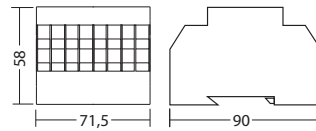

- Sub circuit monitor with 3 inputs suitable for DIN rail mounting
- Each of the 3 galvanically separated channels can be used to monitor one distribution board/ distribution board outgoing
- Changeover devices are linked/ assigned by software via the CPS control module
- Address range 1...31
- Bus line to communicate failure status of monitored distribution boards/ circuits in text format at the CPS control module
- Delay time 0-15min after mains return
- Three phase monitoring with activation level $0.85 \times U_N$

DPÜ/B.2

Phase monitoring module

Art. no. 101434112

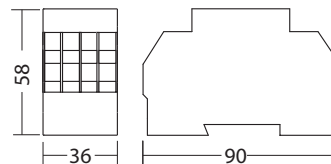

- Three phase monitor with volt free failure indication contact for DIN rail mounting
- Volt free contact can be wired to LSA8.1 (24V) channel for assignments to changeover devices
- Voltage 230V/400V AC 50/60Hz, Threshold $0.85 \times U_N$
- LED indication for L1, L2 & L3

DPÜ

Phase monitoring module

Art. no. 101432391

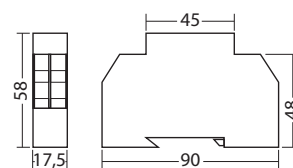

Note: For detailed technical data on each module including options, please contact Regional office of INOTEC



- Relay interface for remote switching and status indication
- 5 volt free contacts for:
 - Operation
 - Battery operation
 - Failure (general)
 - Freely programmable x 2
- Battery sensor output for temperature controlled charging with safety shutdown feature.
- Single phase monitoring with activation level $0.85 \times U_N$
- System blocking function
- 24V, 1A contact available
- Contact status
 - Contact 1-2: Open – Sum failure
 - Contact 3-4: Closed – Operation
 - Contact 5-6: Closed – Battery operation
 - Contact 7-8 : Freely assignable
 - Contact 9-10: Freely assignable

RIF 5

Relais interface with phase monitoring

Art. no. 100893639

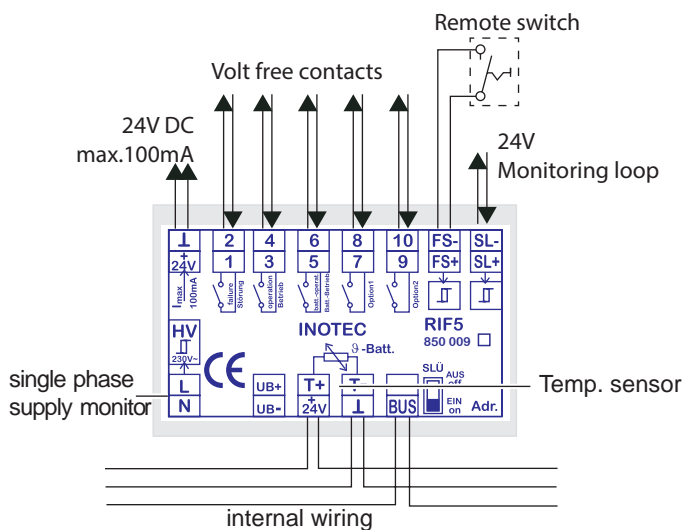
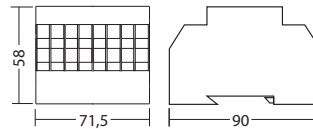

Note: For detailed technical data on each module including options, please contact Regional office of INOTEC



BCS – Battery Control System Battery monitoring module
 Art. no. 101514035

- For monitoring and logging individual block voltage and temperature of battery sets
- Monitoring of upto 36 individual blocks
- When used, replaces RIF 5 including all its functions
- Fully integrated into control module software to enable safety switch off of charger and cancellation of battery duration test when battery blocks deviates from limits
- Works in combination with TFT controller in the panel
- Comprises sensors which can be placed on each battery block
- Safeguards installation against common battery failure type like dry out, Thermal runaway, plate short circuit and sudden death
- Display of each battery block status including live logging of battery block status in the TFT Controller of panel
- INOTEC developed in house software to integrate BCS with CPS TFT touch controller

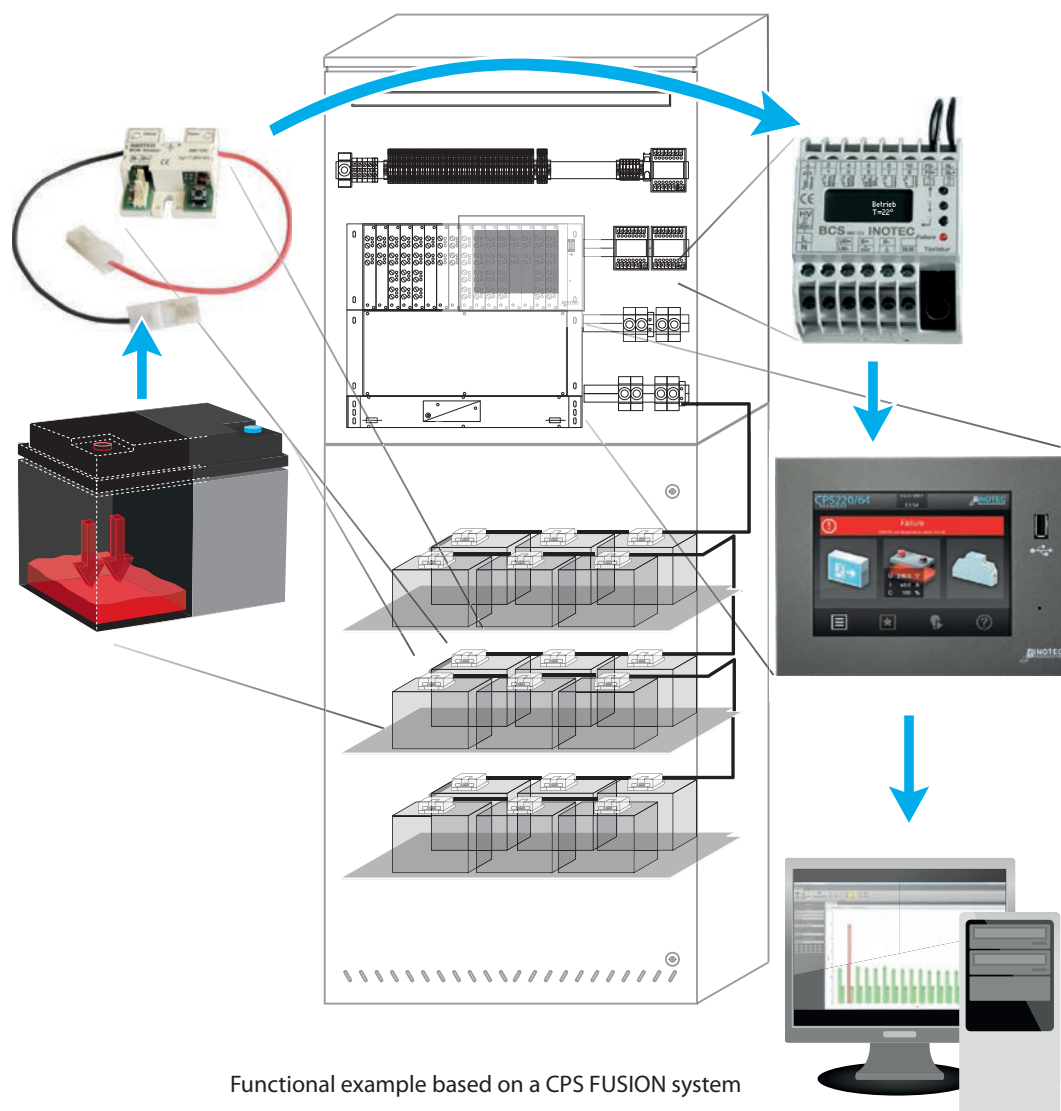
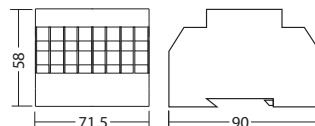

Functional example based on a CPS FUSION system



- Address module with 20 addresses for single lamp monitoring
- With sense input for switching emergency and mains luminaires with the same switch
- Wiring terminals 2.5mm² solid core or 1.5mm² stranded
- Various options available from 5-120W up to 300W
- Max inrush current of monitored luminaire of 80A/500ms

J-SV-Modul../S

Art. no. 101416429

Luminaire module

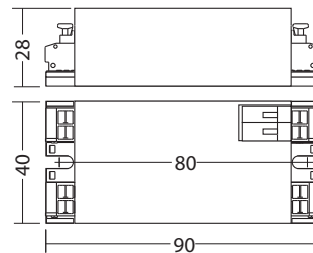

- LED driver, 320mA constant current output (24V DC) for connection to CPS systems
- 20 addresses for single lamp monitoring
- Provided in-built in all safety and exit luminaires supplied by INOTEC
- Dimmable via built in rotary switch in mains supply 0-100%, light output at DC operation 100%
- Optional sense input available for local mains circuit monitoring
- Wiring terminals 2.5mm² solid core or 1.5mm² stranded

J-ET 9/24 SV

Art. no. 101420267

Luminaire module

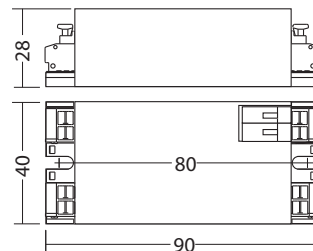

- Address module with 20 addresses for single lamp monitoring of DALI controlled lights from CPS panels
- Dimmable in DC operation in steps of 10% upto 100%
- Wiring terminals 1.5mm² solid core

DALI-SV-Modul

Art. no. 101417540

Luminaire module

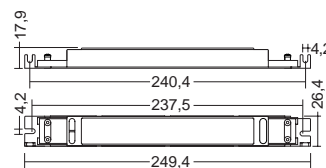

- BUS-interrupter-module for 1-10V controlled lights from CPS panels
- Wiring terminals 1.5mm² solid core

BUS-Interrupter Modul

Art. no. 101417742

Luminaire module

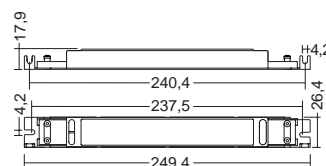

Note: For detailed technical data on each module including options, please contact Regional office of INOTEC



- Microprocessor based central monitoring controller.
- Futuristic slim design to enable wall mounting in aesthetically critical areas too
- OLED graphic display with clear text information.
- LED indications for operation, battery operation and failure(general).
- Complete system status from each panel including end luminaire status with text location info
- Monitoring upto 8 panels in each date line. Upto two data lines available
- Robust simple three core conductor wiring to panels
- Manual and automatic activation of function and duration test at freely definable intervals
- Current loop to block/unblock connected systems
- Four volt free outputs built in to provide signal for:
 - Operation
 - Battery operation
 - Failure
 - Freely programmable

MTB

Central monitoring controller

Art. no. 102148878

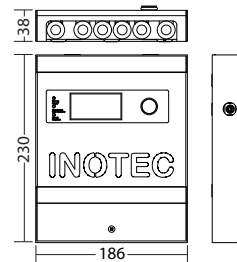

Touch TFT-controller with integrated INOWeb function for centralised monitoring of the CPS 220/48.1 emergency lighting device via the intranet/internet. An existing network is used for connection purposes.

The emergency lighting devices are monitored by accessing the controller's INOWeb functionality (by means of the web browser). Every system, circuit and luminaire status can be checked by the password-protected (optional) website.

It is also possible to monitor systems on a PC with internet access if an internet connection is already in place. For demonstration purposes, please contact your regional technical sales team.

Functions:

- ▶ Starting a function test
- ▶ Blocking / unblocking
- ▶ Failure printout
- ▶ Static building layout visualisation by linking local files or URLs

Modbus/IP gateway is standard in the INOWeb module to communicate with BMS over open protocol. As an option, an external Bacnet/IP gateway can be provided as a specific requirement for a project.

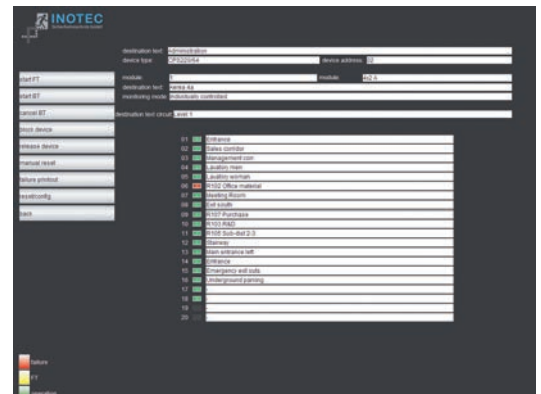
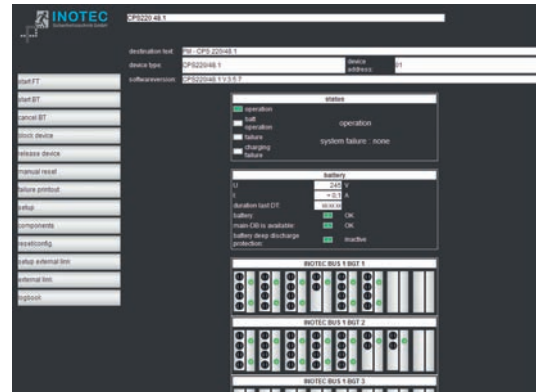

Using the INOWeb Control software, it is also possible to monitor complex installations containing a range of system types from a single centralised location. To perform this process, the comfort TFT-controller must be connected to the available network.

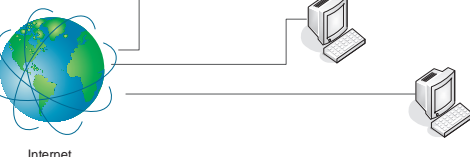
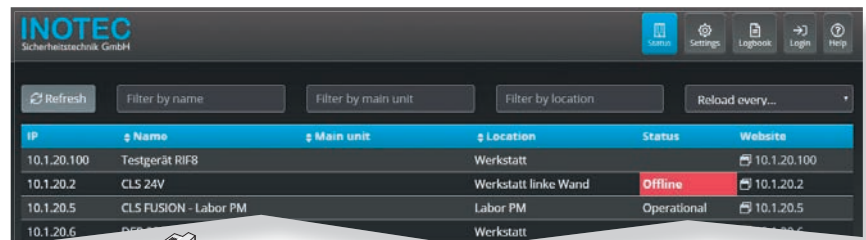
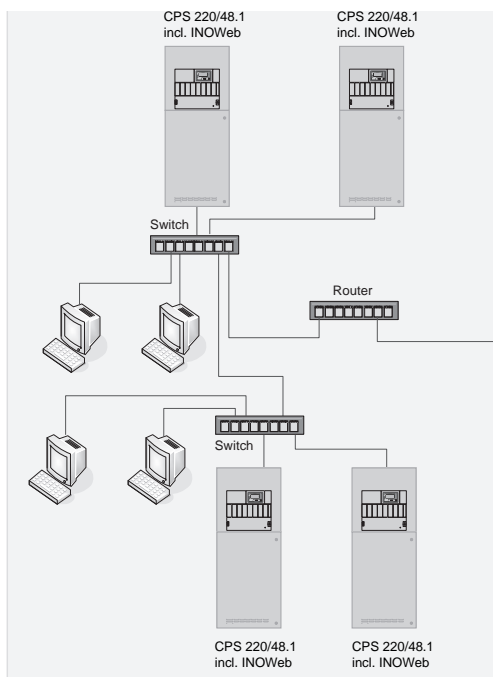

INOWeb-Control functionalities:

- ▶ Monitoring of up to 25 INOTEC emergency lighting units, optional expandable
- ▶ Automatic function-/battery duration test programmable
- ▶ Logbook function for all connected devices
- ▶ Automatic sending of e-mails at adjustable intervals, on test or error
- ▶ Visualization of overall condition of all systems by an icon in the task bar



Protection class: I
Protection category: IP20
Perm. ambient temperature:
for the device: -5°C to +35°C,
 max. 85% rel. humidity,
 non condensing
for the battery: acc. data sheet
Battery: 216V DC
Housing color: RAL 7035

Cable inlet from top

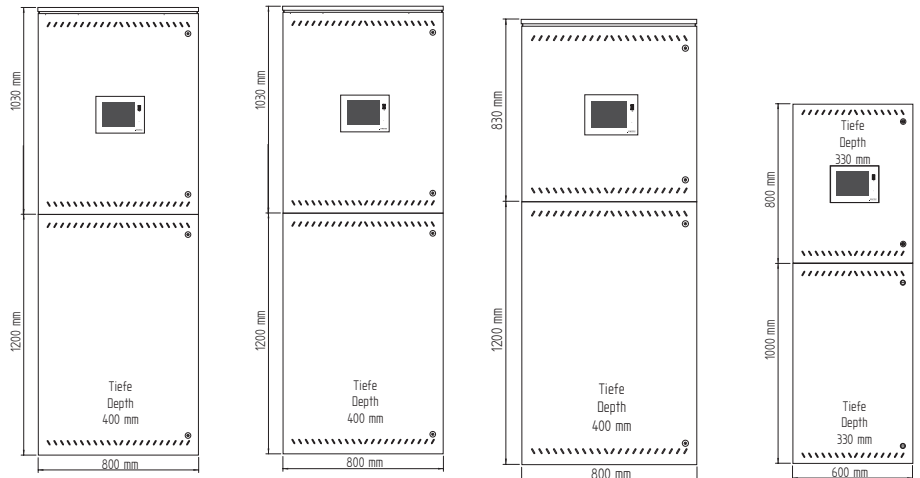

CPS 220/48.1/0

CPS 220/48.1/48
CPS 220/48.1/32

CPS 220/48.1/16

CPS 220/48.1/11

Connection voltage:	3~N/PE, 400V AC ±10%, 50/60Hz ±2%	3~N/PE, 400V AC ±10%, 50/60Hz ±2%	1~N/PE, 230V AC ±10%, 50/60Hz ±2%	1~N/PE, 230V AC ±10%, 50/60Hz ±2%
Free module slots SKE 2x3A / SKE 1x6A max. internal/external	0	24 / 24 16 / 24	8 / 24	11 / -
Max. installed battery capacity	75Ah	75Ah	75Ah	28Ah
Charger	3A or 7A	3A or 7A	3A or 7A	3A
Space for options	3 x 12TE	3 x 12TE	2 x 12TE	4TE
3-phase supply (option)	only 3-phase	only 3-phase	yes	-
Conductor cross section, max. (mm²)				
Mains supply	35	35	35	10
Battery supply	35	35	35	35
Outgoing to luminaires	4	4	4	4
Outgoing line (RTG)	4	4	4	4
Outgoing IB2/IB3	4	4	4	4
Outgoing 24V monitoring	4	4	4	4
Outgoing mains to CPUS	35	35	35	-
Outgoing battery to CPUS	35	35	35	-
Dimensions H x W x D (mm)	2230 x 800 x 400	2230 x 800 x 400	2030 x 800 x 400	1800 x 600 x 330
Cable inlets:	22 x M20 / 64 x M25 6 x M32 / 2 x M50	22 x M20 / 64 x M25 6 x M32 / 2 x M50	22 x M20 / 64 x M25 6 x M32 / 2 x M50	7 x M20 / 30 x M25 4 x M32



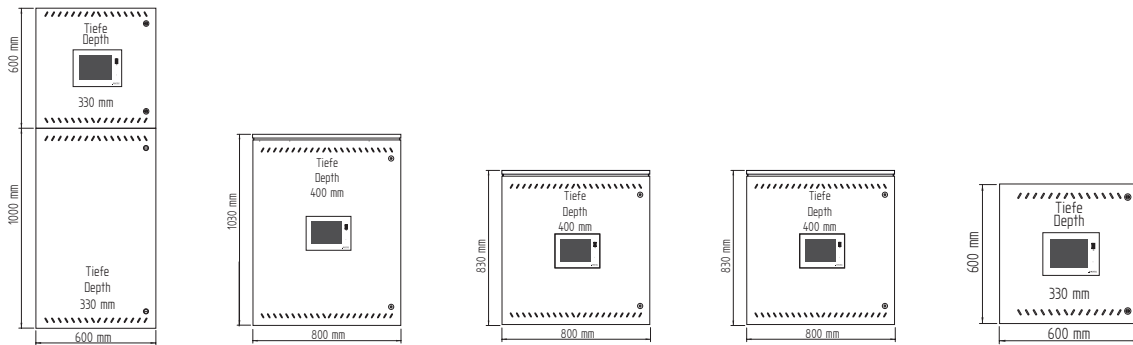

CPS 220/48.1/5

CPUS 220/48.1/48

CPUS 220/48.1/32

CPUS 220/48.1/16

CPUS 220/48.1/5

1~N/PE, 230V AC ±10%, 50/60Hz ±2%	1~N/PE, 230V AC ±10%, 50/60Hz ±2%	1~N/PE, 230V AC ±10%, 50/60Hz ±2%	1~N/PE, 230V AC ±10%, 50/60Hz ±2%	1~N/PE, 230V AC ±10%, 50/60Hz ±2%
5 / -	24 / 24	16 / 24	8 / 24	5 / -
28Ah	-	-	-	-
3A	-	-	-	-
7TE	3 x 12TE	2 x 12TE	2 x 12TE	7TE
-	yes	yes	-	-
10	35	35	35	10
35	35	35	35	35
4	4	4	4	4
4	4	4	4	4
4	4	4	4	4
4	4	4	4	4
-	-	-	-	-
-	-	-	-	-
1600 x 600 x 330	1030 x 800 x 400	830 x 800 x 400	830 x 800 x 400	600 x 600 x 330
7 x M20 / 30 x M25 4 x M32	22 x M20 / 64 x M25 6 x M32 / 2 x M50	22 x M20 / 64 x M25 6 x M32 / 2 x M50	22 x M20 / 64 x M25 6 x M32 / 2 x M50	7 x M20 / 30 x M25 4 x M32



Protection class: I

Protection category: IP20

Perm. ambient temperature:

for the device: -5°C to +35°C,
max. 85% rel. humidity,
non condensing

Housing color: RAL 7035

Cable inlet from top

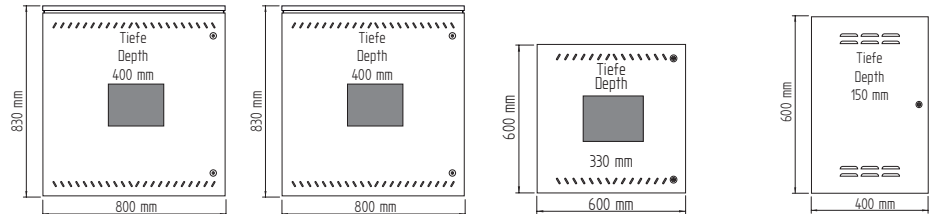

	CPUSB 220/48.1/48	CPUSB 220/48.1/32	CPUSB 220/48.1/16	CPUSB 220/48.1
Connection voltage	3~N/PE, 400V AC ± 10% 50/60Hz ± 2%	3~N/PE, 400V AC ± 10% 50/60Hz ± 2%	1~N/PE, 230V AC ± 10% 50/60Hz ± 2%	1~N/PE, 230V AC ± 10% 50/60Hz ± 2%
Free module slots SKE 2x3A / SKE 1x6A max. internal/ external	24	16	8	3 (only 2x3A)
Space for options	2 x 12TE	2 x 12TE	2TE	-
3-phase supply (option)	1-phase (option)	1-phase (option)	-	-
Conductor cross section, max.(mm²)				
Mains supply	35	35	35	10
Battery supply	35	35	35	10
Outgoing to luminaires	4	4	4	4
Outgoing IB2/IB3	4	4	4	4
Dimensions H x W x D (mm)	830 x 800 x 400	830 x 800 x 400	600 x 600 x 330	600 x 400 x 150
cable inlets:	22 x M20 / 64 x M25 6 x M32 / 2 x M50	22 x M20 / 64 x M25 6 x M32 / 2 x M50	7 x M20 / 30 x M25 4 x M32	13 x M25 4 x M35

Required space for options

1 DU	2 DU	3 DU	4 DU	5 DU	7 DU
DPÜ (Three-phase monitoring)	Fused Neo- zed for 3-phase connection	LSA 3.1 24V, incl. 2 terminals - extension *2, *4	LSA 3.1 24V, incl. 2 terminals + 24V PSU - basic set *1, *3	LSA 8.1 24V, incl. 4 terminals - extension *2, *4	LSA 8.1 24V, incl. 4 terminals +24V PSU - basic set *1, *3
LSA 3.1	DPÜ / B.2		LSA 8.1		Fuse outlet mains (3-phase) for sub-station (Neozed)
LOMO			RIF 5 BCS IB Repeater Fuse outlet battery for sub-station (Neozed)		
			Fuse outlet mains (1-phase) for substation (Neozed)		

*1 First LSA xxx 24V prewired, incl. 24V PSU, for additional use the extension

*2 Additional LSA xxx 24V prewired, without 24V PSU, in combination with the basic set

*3 Not for use with CPS (CPUS) 220/48.1/5 and 11, built in compact cabinets (600mm wide)

*4 For use with CPS (CPUS) 220/48.1/5 and 11, built in compact cabinets (600mm wide)



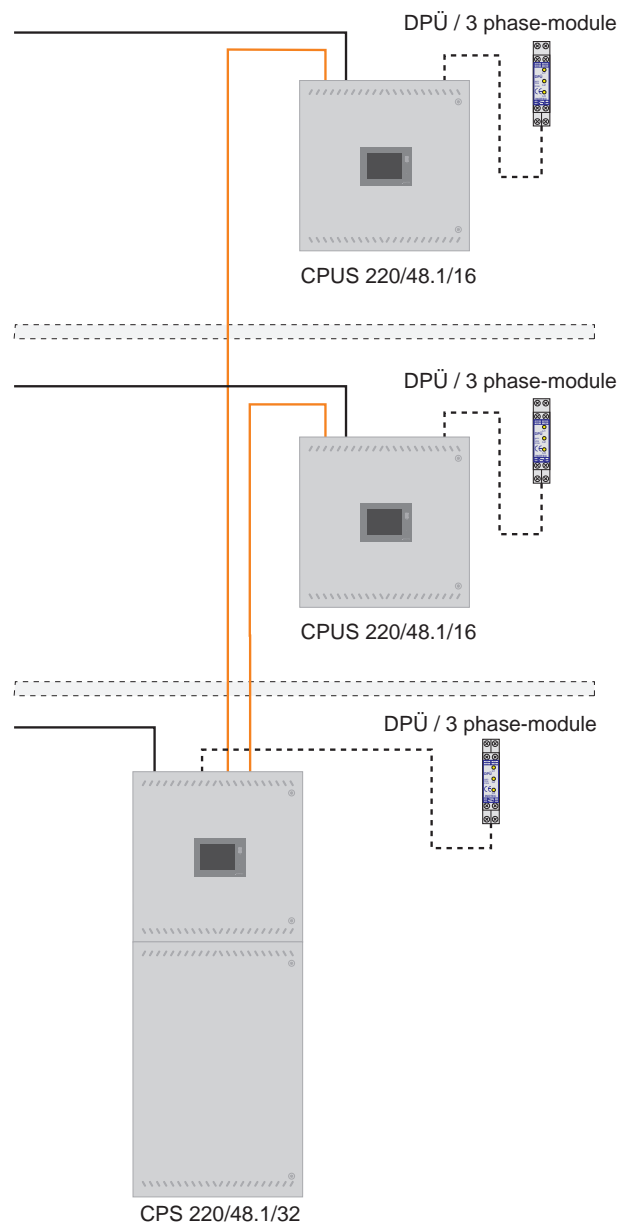
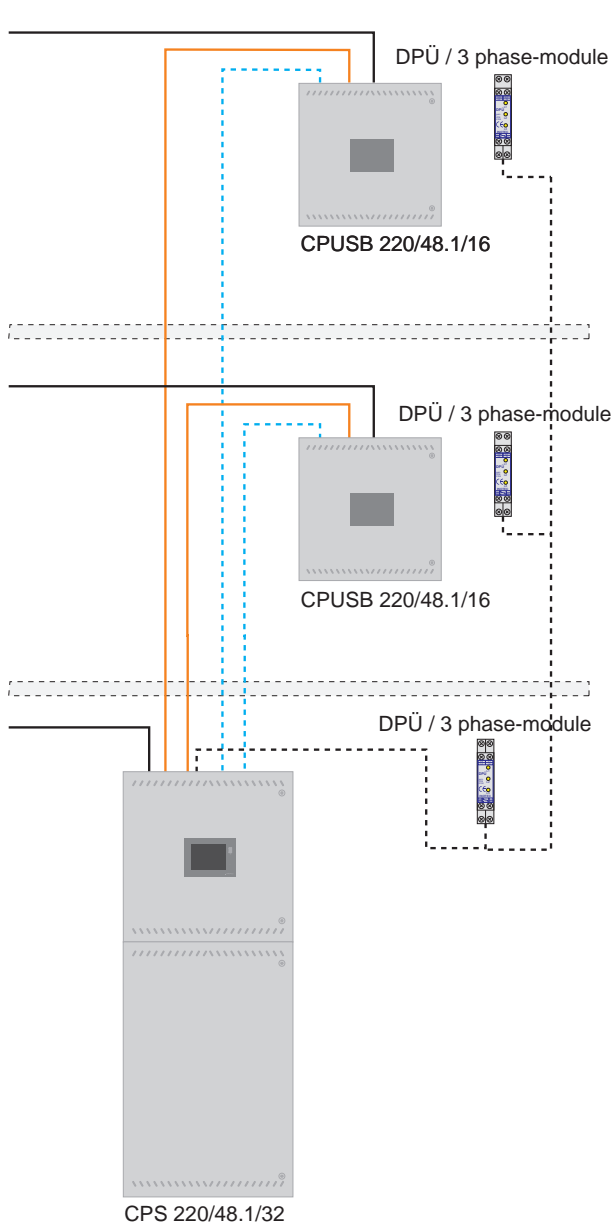
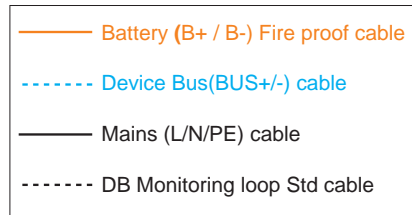



INOTEC Sicherheitstechnik GmbH
Am Buschgarten 17
D - 59 469 Ense

Tel +49 29 38/97 30-0

Fax +49 29 38/97 30-29

info@inotec-licht.de

www.inotec-licht.de

